

Vážení zákazníci,

dovolujeme si představit Vám náš nový katalog, který – jak doufáme – šířkou sortimentu uspokojí všechny Vaše představy a požadavky. Vybrali jsme pro Vás kliky a kování vysoké kvality výhradně od evropských výrobců, přičemž jsme kladli důraz na zajímavý design, kvalitu a příznivé ceny.

Věříme, že naše nabídka Vás zaujme a že Vám naše výrobky budou sloužit dlouho a k Vaší plné spokojenosti.

Martinelli, s. r. o.

NĚKOLIK RAD PŘED ZAKOUPENÍM KLIK

Typy otvorů

Klika s koulí

Povrchové úpravy

Ošetřování

Štíťové kliky

U štíťových klik musíte znát vzdálenost mezi osou kliky a osou klíče (standardní vzdálenost je 72 mm nebo 90 mm).

UPOZORNĚNÍ: Jelikož otvory do štíťových klik vyrábíme na objednávku, je nutné, aby zákazník znal typ a rozteč otvorů při zadávání objednávky. Pokud zákazník objedná nesprávný typ a rozteč otvorů, nemusí být výměna za správný typ a rozteč samozřejmostí.

Rozetové kliky

Rozetové neboli dělené kliky se označují velkým R. Jelikož většina rozetových klik se upevňuje prošroubováním skrz celou tloušťku dveří v místě zámku, je potřeba, aby v zámku byly k tomu určené otvory.

Zkratkou BB označujeme otvor pro interiérový klíč (dózický).

Zkratkou PZ označujeme otvor pro vložku (fabku).

Zkratkou WC označujeme otvor pro WC-sadu s vmontovaným klíčem (k WC-sadě je potřeba zámek se spodním čtverhranným otvorem 6×6 mm).

U klik s koulí uvádíme všechny předešlé údaje plus upřesnění, zda se jedná o kliku pravou nebo levou. Pro upřesnění kliky levé používáme zkratku LI a pravé RE. Dále je potřeba uvést, zda se jedná o kouli pevnou nebo otočnou.

Na straně 4 katalogu jsou uvedeny zkratky pro povrchové úpravy našich výrobků.

UPOZORNĚNÍ: Na místech se zvýšenou frekvencí pohybu lidí a ve znečištěném pro-středí není vhodné použít lakované povrchy (OLV – mosaz leštěná, OGR – mosaz pobronzovaná, ONS – nikl matný). Do takových prostorů je vhodný nerez, chrom lesklý, chrom broušený, PVD a PVD+NOX.

Ošetřování

Na čištění a ošetřování nepoužívejte žádné agresivní chemikálie a čisticí prostředky. Čistěte jen měkkým vlhkým hadříkem. Výrobky montujte až po vymalování stěn místnosti, po natření oken, dveří, podlah atd.

ZÁRUČNÍ PODMÍNKY

Záruka na výrobky uvedené v katalogu je 2 roky od data prodeje vyznačeného na pokladním dokladu. Na speciálně označené výrobky je poskytována záruka 3, 5 nebo 10 let.

Záruka sa nevztahuje na poškození výrobku nesprávným ošetřováním a na opotřebování výrobku používáním. Záruka sa též nevztahuje na výrobky, které byly po zakoupení dodatečně upravovány zákazníkem nebo jeho montážníkem.

VÝMĚNA ZBOŽÍ

Při jakémkoliv nároku na výměnu nebo reklamaci zboží žádáme zákazníky, aby jednotlivé díly zabalili tak, aby nedošlo k jejich dalšímu poškození.

Za pochopení děkujeme a doufáme, že budete s naším zbožím a službami spokojeni.

| označení | materiál |
|----------|--|
| OLV | leštěná lakovaná mosaz |
| OS | matná mosaz |
| OLS | lesklá mosaz / matná mosaz |
| OGR | česaná pobronzovaná mosaz |
| OF | pobronzovaná mosaz |
| OGH | matná česaná pobronzovaná mosaz |
| OC | lesklý chrom |
| OCS | broušený chrom |
| ONS | satinovaný nikel |
| CCS | lesklý chrom / broušený chrom |
| CNS | lesklý chrom / satinovaný nikel |
| BSS | tmavý bronz |
| AF | starý bronz |
| FAN | starý chrom |
| AB+P8 | antický bronz + béžový „prasklý“ porcelán |
| ONS+P9 | satinovaný nikel + bílý „prasklý“ porcelán |
| OC+P9 | lesklý chrom + bílý „prasklý“ porcelán |
| OBS | přírodní mosaz |
| SIL | antické stříbro |
| PVD | zirkonium (záruka na povrch 20 let) |
| PVD INOX | inox zirkonium (záruka na povrch 20 let) |
| F1 | přírodní elox |
| F4 | bronzový elox |
| F3 | zlatý elox |
| F9 | nerezový elox |



| | |
|----------------|----|
| Kilky | |
| Appia | 7 |
| Latina | 8 |
| Nova | 9 |
| Nova B | 10 |
| Nova C | 11 |
| Link | 12 |
| Link B | 13 |
| Handy | 14 |
| Fast | 15 |
| Beverly | 16 |
| Cottage | 17 |
| Arcadia | 18 |
| Tesa | 19 |
| Tipo | 20 |
| Lady | 21 |
| Classic | 22 |
| Lirica | 23 |
| Noxia | 24 |
| Noxia B | 25 |
| Polo | 26 |
| Lorena | 27 |
| Carola | 28 |
| Wing | 29 |
| Ovale | 30 |
| Daniela | 31 |
| Kristina | 32 |
| Laura | 33 |
| Prelude | 34 |
| Katy | 35 |
| Beaty | 36 |
| Doria | 37 |
| Lara | 38 |
| Serena | 38 |

| | |
|----------------|----|
| Paperino | 39 |
| Palermo | 39 |
| Latina | 41 |
| Beverly | 41 |
| Only | 42 |
| Elena | 42 |
| Onda | 43 |
| Lirica | 43 |
| Katy | 44 |
| Daniela | 44 |
| Sabina | 45 |
| Sara | 45 |

Kování na francouzská okna

| | |
|------------------|----|
| Koule | |
| Easy | 47 |
| Sfera | 48 |
| Diamante | 49 |
| Georgian | 50 |
| Victorian | 51 |
| Margherita | 52 |

| | |
|-----------------|----|
| Klepadla | |
| Leone | 53 |
| Zvonky | 53 |
| Barocco | 54 |
| Esagono | 54 |
| America | 55 |
| Anello | 55 |
| Victorian | 56 |
| Georgian | 56 |

Zámky na posuvné dveře

| | |
|---------------------------|----|
| Mušle dveřní | 58 |
| Rettangolo | 59 |

| | |
|------------------------------|----|
| Daniela | 59 |
| Lorena | 60 |
| Noxia | 60 |
| Dveřní zarážky | 61 |
| Držáky zábradlí | 61 |
| Dopisní vhozy | 62 |
| Bezpečn. rozety | 63 |
| Kilky nerezové | |
| Uno | 65 |
| Due | 65 |
| Look me | 66 |
| Metric | 67 |
| Duo | 68 |
| Quadro | 69 |
| Next | 70 |
| Linear | 71 |
| Athena | 72 |
| Marco | 73 |
| Vision | 74 |
| Loft | 75 |
| Ufo | 76 |
| Carlo | 77 |
| Nord | 78 |
| Arco | 79 |
| Vega | 80 |

| | |
|---------------------|----|
| Madla | |
| Madlo 7204 | 81 |
| Madlo 7207 | 81 |
| Madlo 7287 | 82 |
| Madlo 7289 | 82 |
| Madlo 7200 | 83 |
| Madlo 7286 | 83 |
| Madlo kubické | 84 |

| | |
|------------------------------|----|
| Madlo koule | 85 |
| Madlo válcové | 86 |
| Madlo vyosené | 87 |
| Mušle | 88 |
| Dveřní zarážky | 89 |
| Držáky zábradlí | 89 |
| Dopisní vhozy | 90 |
| Rozety | 91 |
| Monet | 93 |
| Universal | 93 |
| Corner | 94 |
| Modus | 94 |
| Praha | 95 |
| Klasik | 95 |
| Mira | 96 |
| Sabina | 96 |
| Sina | 97 |
| Sina | 97 |
| Štít s koulí | 98 |
| Koule pevná | 98 |
| Okenní půloliva | 98 |
| Okenní oliva | 98 |
| Okenní rozvora | 98 |
| Okenní kl. Praha | 98 |
| Okenní kl. Sina | 98 |

Bezpečnostní kování

| | |
|---------------------------|---------|
| Bezpečn. kov. Brema | 99 |
| Bezpečn. kov. Axa | 100 |
| Bezpečn. kov. Prestige .. | 101 |
| Dveřní závěsy | |
| Ozdobné číslice | 103 |
| Dveřní zarážka | 103 |
| Dveřní závěsy | 104-108 |



martinelli[®]
HANDLES WITH CARE



Appia-R (BSS)



Appia



Appia-DK



Appia-HR

APPIA

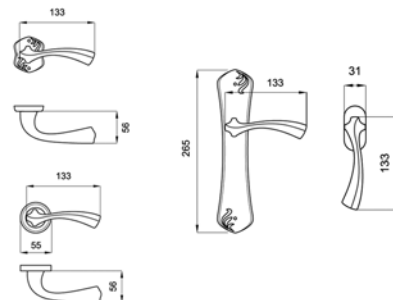

OGH



ONS



OLV



OC



| | | Typ povrchové úpravy | | | | | | | |
|-------------|------------|----------------------|------|------|------|------|------|------|----------|
| | | OLV | BSS | OGH | OC | OCS | ONS | PVD | PVD INOX |
| Appia-R, HR | BB, PZ | 1593 | 1593 | 1753 | 1753 | 1753 | 1912 | 2471 | 2471 |
| | WC, KPZL/R | 1785 | 1984 | 1984 | 1984 | 1984 | 2173 | 2833 | 2833 |
| Appia | BB, PZ | 2069 | 2276 | 2276 | 2276 | 2276 | 2482 | 2935 | 2935 |
| | WC, KPZL/R | 2260 | 2507 | 2507 | 2507 | 2507 | 2743 | 3298 | 3298 |
| Appia-DK | | 725 | 798 | 798 | 798 | 798 | 870 | 1103 | 1103 |



Latina-HR (OGH)



Latina-DK



Latina

LATINA

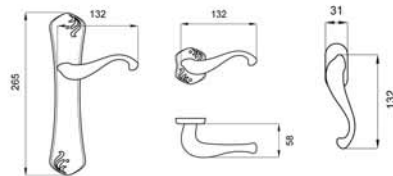

OLV



OC



BSS



ONS



| | | Typ povrchové úpravy | | | | | | | |
|-----------|------------|----------------------|------|------|------|------|------|------|----------|
| | | OLV | BSS | OGH | OC | OCS | ONS | PVD | PVD INOX |
| Latina-HR | BB, PZ | 1593 | 1593 | 1593 | 1593 | 1593 | 1912 | 2471 | 2471 |
| | WC, KPZL/R | 1785 | 1984 | 1984 | 1984 | 1984 | 2173 | 2833 | 2833 |
| Latina | BB, PZ | 2069 | 2276 | 2276 | 2276 | 2276 | 2482 | 2935 | 2935 |
| | WC, KPZL/R | 2260 | 2507 | 2507 | 2507 | 2507 | 2743 | 3298 | 3298 |
| Latina-DK | | 725 | 798 | 798 | 798 | 798 | 870 | 1103 | 1103 |



Nova-HR (OCS)



Nova-DK



Nova

NOVA

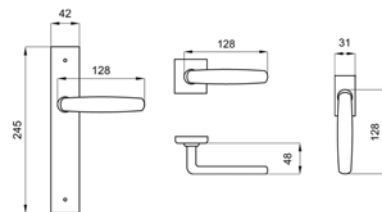

OC



OS



OLV



OCS



| | | Typ povrchové úpravy | | | | | | | |
|---------|------------|----------------------|------|------|------|------|------|----------|--|
| | | OLV | OS | OC | OCS | ONS | PVD | PVD INOX | |
| Nova-HR | BB, PZ | 1006 | 1006 | 1107 | 1107 | 1207 | 1574 | 1574 | |
| | WC, KPZL/R | 2857 | 2857 | 1338 | 1338 | 1469 | 1946 | 1946 | |
| Nova | BB, PZ | 1092 | 1092 | 1201 | 1201 | 1310 | 1754 | 1754 | |
| | WC, KPZL/R | 1284 | 1284 | 1432 | 1432 | 1571 | 2117 | 2117 | |
| Nova-DK | | 527 | 527 | 580 | 580 | 632 | 815 | 815 | |



Nova B (CCS)



Nova B-DK

NOVA B

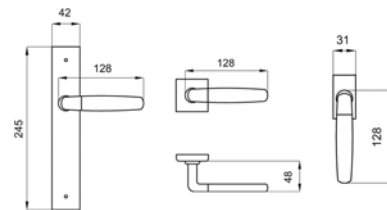

Nova B-HR



OLS



CCS



| | | Typ povrchové úpravy | | | | | |
|-----------|------------|----------------------|------|--|--|--|--|
| | | OLS | CCS | | | | |
| Nova B-HR | BB, PZ | 1167 | 1283 | | | | |
| | WC, KPZL/R | 1359 | 1515 | | | | |
| Nova B | BB, PZ | 1255 | 1380 | | | | |
| | WC, KPZL/R | 1446 | 1612 | | | | |
| Nova B-DK | | 608 | 662 | | | | |



Nova C–DK

NOVA C

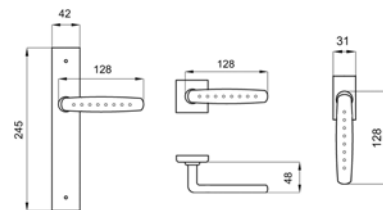

Nova C–HR (OCS)



Nova C



ONS



OLV



PVD



PVD INOX



| | | Typ povrchové úpravy | | | | | | |
|-----------|------------|----------------------|------|------|------|------|------|----------|
| | | OLV | OS | OC | OCS | ONS | PVD | PVD INOX |
| Nova C–HR | BB, PZ | 1076 | 1076 | 1184 | 1184 | 1291 | 1655 | 1655 |
| | WC, KPZL/R | 1268 | 1268 | 1415 | 1415 | 1552 | 2017 | 2017 |
| Nova C | BB, PZ | 1162 | 1162 | 1278 | 1278 | 1395 | 1824 | 1824 |
| | WC, KPZL/R | 1354 | 1354 | 1509 | 1509 | 1656 | 2187 | 2187 |
| Nova C–DK | | 562 | 562 | 618 | 618 | 674 | 851 | 851 |

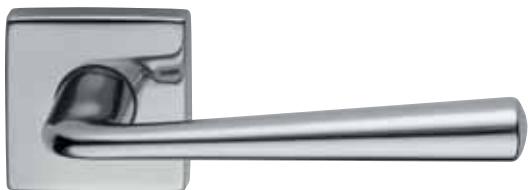

Link-HR (OC)



Link-DK



Link

LINK

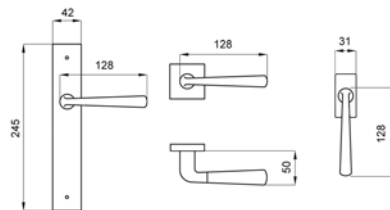

ONS



OCS



PVD INOX



OS



| | | Typ povrchové úpravy | | | | | | | |
|---------|------------|----------------------|------|------|------|------|------|----------|--|
| | | OLV | OS | OC | OCS | ONS | PVD | PVD INOX | |
| Link-HR | BB, PZ | 979 | 979 | 1079 | 1079 | 1180 | 1556 | 1556 | |
| | WC, KPZL/R | 1171 | 1171 | 1311 | 1311 | 1442 | 1918 | 1918 | |
| Link | BB, PZ | 1064 | 1064 | 1174 | 1174 | 1284 | 1726 | 1726 | |
| | WC, KPZL/R | 1256 | 1256 | 1405 | 1405 | 1546 | 2088 | 2088 | |
| Link-DK | | 512 | 512 | 539 | 539 | 619 | 802 | 802 | |



Link B (CCS)



Link B-DK

LINK B

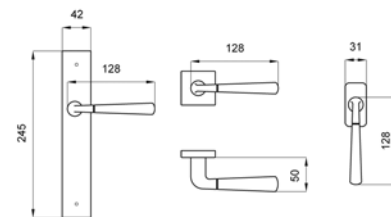

Link B-HR



OLS



CCS



| | | Typ povrchové úpravy | | | | | |
|-----------|------------|----------------------|------|--|--|--|--|
| | | OLS | CCS | | | | |
| Link B-HR | BB, PZ | 1140 | 1256 | | | | |
| | WC, KPZL/R | 1332 | 1488 | | | | |
| Link B | BB, PZ | 1228 | 1353 | | | | |
| | WC, KPZL/R | 1419 | 1585 | | | | |
| Link B-DK | | 594 | 634 | | | | |



Handy (OC)



Handy-DK

HANDY

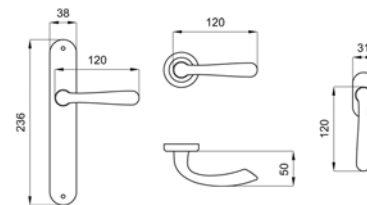

Handy-R



OS



OGR



OCS



ONS



| | | Typ povrchové úpravy | | | | | | | |
|----------|------------|----------------------|-----|-----|-----|-----|-----|--|--|
| | | OLV | OS | OGR | OC | OCS | ONS | | |
| Handy-R | BB, PZ | 510 | 510 | 510 | 581 | 581 | 675 | | |
| | WC, KPZL/R | 702 | 702 | 702 | 813 | 813 | 937 | | |
| Handy | BB, PZ | 510 | 510 | 510 | 581 | 581 | 675 | | |
| | WC, KPZL/R | 702 | 702 | 702 | 813 | 813 | 937 | | |
| Handy-DK | | 318 | 318 | 318 | 349 | 349 | 381 | | |



Fast-R (ONS)



Fast-DK

FAST

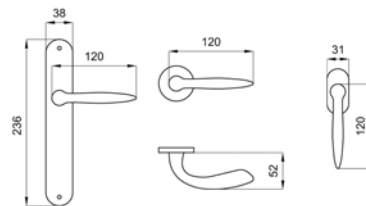

Fast



OLV



OS



OCS



OGR



| | | Typ povrchové úpravy | | | | | | | |
|---------|------------|----------------------|-----|-----|-----|-----|-----|--|--|
| | | OLV | OS | OGR | OC | OCS | ONS | | |
| Fast-R | BB, PZ | 510 | 510 | 510 | 581 | 581 | 675 | | |
| | WC, KPZL/R | 702 | 702 | 702 | 813 | 813 | 937 | | |
| Fast | BB, PZ | 510 | 510 | 510 | 581 | 581 | 675 | | |
| | WC, KPZL/R | 702 | 702 | 702 | 813 | 813 | 937 | | |
| Fast-DK | | 318 | 318 | 318 | 349 | 349 | 381 | | |

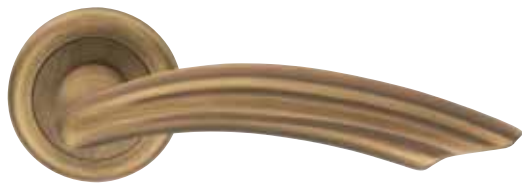

Beverly-R (OGH)



Beverly-DK



Beverly

BEVERLY

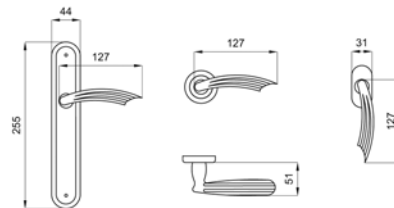

OLV



OS



PVD INOX



OGR



| | | Typ povrchové úpravy | | | | | | |
|------------|------------|----------------------|------|------|------|------|------|----------|
| | | OLV | OS | OGH | OGR | SIL | PVD | PVD INOX |
| Beverly-R | BB, PZ | 1741 | 1741 | 1910 | 1741 | 1910 | 2511 | 2511 |
| | WC, KPZL/R | 1933 | 1933 | 2142 | 1933 | 2142 | 2874 | 2874 |
| Beverly | BB, PZ | 1518 | 1518 | 1753 | 1518 | 1753 | 2183 | 2183 |
| | WC, KPZL/R | 1710 | 1710 | 1985 | 1710 | 1985 | 2546 | 2546 |
| Beverly-DK | | 750 | 750 | 862 | 750 | 862 | 1175 | 1175 |

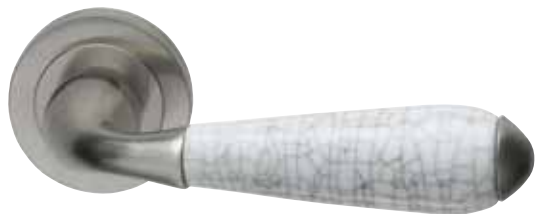

Cottage-R (ONS + P9)



Cottage-DK



Cottage

COTTAGE

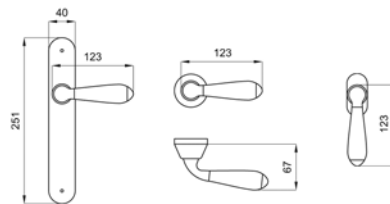

OLS



AB+P8



CCS



CNS



| | | Typ povrchové úpravy | | | | | | | |
|------------|------------|----------------------|------|------|---------|----------|---------|--|--|
| | | OLS | CCS | CNS | AB + P8 | ONS + P9 | OC + P9 | | |
| Cottage-R | BB, PZ | 1731 | 1905 | 2030 | 1868 | 2241 | 2054 | | |
| | WC, KPZL/R | 1923 | 2135 | 2262 | 2099 | 2502 | 2286 | | |
| Cottage | BB, PZ | 1445 | 1589 | 1715 | 1581 | 1898 | 1739 | | |
| | WC, KPZL/R | 1637 | 1821 | 1947 | 1813 | 2158 | 1971 | | |
| Cottage-DK | | 725 | 793 | 848 | 860 | 967 | 881 | | |



Arcadia (OC)



Arcadia-DK

ARCADIA

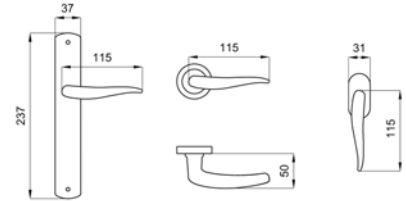

Arcadia-R



OLV



OGR



OCS



ONS



| | | Typ povrchové úpravy | | | | | | | |
|------------|------------|----------------------|-----|-----|-----|------|--|--|--|
| | | OLV | OGR | OC | OCS | ONS | | | |
| Arcadia-R | BB, PZ | 596 | 596 | 737 | 737 | 829 | | | |
| | WC, KPZL/R | 776 | 776 | 965 | 965 | 1086 | | | |
| Arcadia | BB, PZ | 596 | 596 | 737 | 737 | 829 | | | |
| | WC, KPZL/R | 779 | 776 | 965 | 965 | 1086 | | | |
| Arcadia-DK | | 354 | 354 | 389 | 389 | 425 | | | |



Tesa-R (OCS)



Tesa-DK



Tesa

TESA

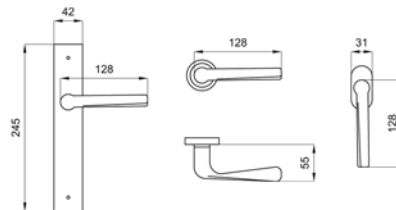

OLV



OS



OC



OCS



| | | Typ povrchové úpravy | | | | | | | |
|---------|------------|----------------------|------|------|------|------|--|--|--|
| | | OLV | OS | OC | OCS | ONS | | | |
| Tesa-R | BB, PZ | 874 | 874 | 941 | 941 | 1116 | | | |
| | WC, KPZL/R | 1067 | 1067 | 1173 | 1173 | 1371 | | | |
| Tesa | BB, PZ | 874 | 874 | 941 | 941 | 1116 | | | |
| | WC, KPZL/R | 1067 | 1067 | 1173 | 1173 | 1371 | | | |
| Tesa-DK | | 496 | 496 | 540 | 54 | 608 | | | |



Tipo-R (OC)



Tipo-DK



Tipo

TIPO

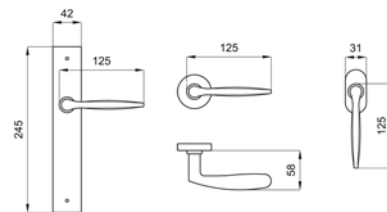

OLV



OS



OCS



ONS



| | | Typ povrchové úpravy | | | | | | | |
|---------|------------|----------------------|------|------|------|------|--|--|--|
| | | OLV | OS | OC | OCS | ONS | | | |
| Tipo-R | BB, PZ | 874 | 874 | 941 | 941 | 1119 | | | |
| | WC, KPZL/R | 1067 | 1067 | 1173 | 1173 | 1371 | | | |
| Tipo | BB, PZ | 874 | 874 | 941 | 941 | 1116 | | | |
| | WC, KPZL/R | 1067 | 1067 | 1173 | 1173 | 1371 | | | |
| Tipo-DK | | 496 | 496 | 540 | 540 | 608 | | | |



Lady-R (BSS)



Lady-DK



Lady

LADY

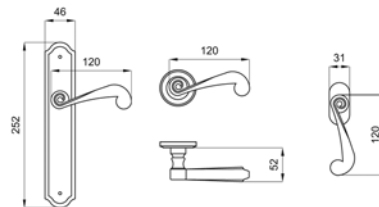

OGR



BSS



PVD



FAN



| | | Typ povrchové úpravy | | | | | | | | |
|---------|------------|----------------------|------|------|------|------|------|--|--|--|
| | | OLV | OGR | OGH | BSS | PVD | FAN | | | |
| Lady-R | BB, PZ | 1468 | 1468 | 1551 | 1551 | 2248 | 1551 | | | |
| | WC, KPZL/R | 1679 | 1679 | 1782 | 1782 | 2611 | 1782 | | | |
| Lady | BB, PZ | 1247 | 1247 | 1286 | 1286 | 2174 | 1286 | | | |
| | WC, KPZL/R | 1457 | 1457 | 1517 | 1517 | 2536 | 1517 | | | |
| Lady-DK | | 632 | 632 | 712 | 712 | 1040 | 712 | | | |



Classic-R (OGR)



Classic-DK



Classic

CLASSIC

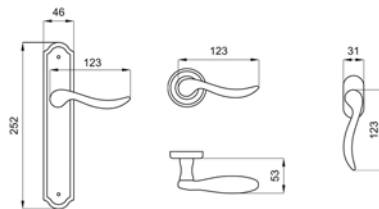

OLV



OGR



PVD

Typ povrchové úpravy

| | | OLV | OGR | PVD | | | | | |
|------------|------------|------|------|------|--|--|--|--|--|
| Classic-R | BB, PZ | 1152 | 1152 | 2066 | | | | | |
| | WC, KPZL/R | 1362 | 1362 | 2428 | | | | | |
| Classic | BB, PZ | 934 | 934 | 1887 | | | | | |
| | WC, KPZL/R | 1145 | 1145 | 2182 | | | | | |
| Classic-DK | | 493 | 493 | | | | | | |





Lirica-R (BSS)



Lirica-DK



Lirica

LIRICA

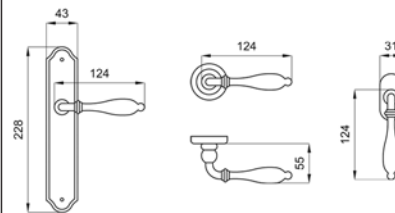

OGH



OGC



BSS



| | | Typ povrchové úpravy | | | | | | | |
|-----------|------------|----------------------|------|------|------|--|--|--|--|
| | | OLV | OGR | OGH | BSS | | | | |
| Lirica-R | BB, PZ | 1286 | 1286 | 1440 | 1440 | | | | |
| | WC, KPZL/R | 1496 | 1496 | 1650 | 1650 | | | | |
| Lirica | BB, PZ | 967 | 967 | 1075 | 1075 | | | | |
| | WC, KPZL/R | 1177 | 1177 | 1285 | 1285 | | | | |
| Lirica-DK | | 570 | 570 | 643 | 643 | | | | |



Noxia-R (OCS)



Noxia-DK

NOXIA

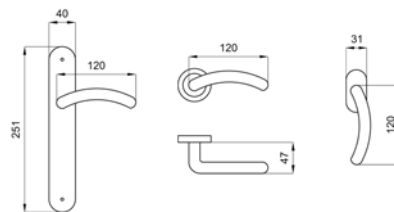

Noxia



OLV



OC



OCS



| | | Typ povrchové úpravy | | | | | | |
|----------|------------|----------------------|------|------|--|--|--|--|
| | | OLV | OC | OCS | | | | |
| Noxia-R | BB, PZ | 671 | 823 | 823 | | | | |
| | WC, KPZL/R | 864 | 1066 | 1066 | | | | |
| Noxia | BB, PZ | 671 | 823 | 823 | | | | |
| | WC, KPZL/R | 864 | 1066 | 1066 | | | | |
| Noxia-DK | | 486 | 535 | 535 | | | | |



Noxia B-R (CCS)



Noxia B-DK



Noxia B

NOXIA B

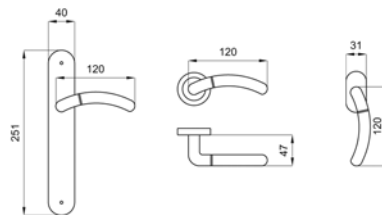

CCS



| | | Typ povrchové úpravy | | | | | |
|------------|------------|----------------------|--|--|--|--|--|
| | | CCS | | | | | |
| Noxia B-R | BB, PZ | 898 | | | | | |
| | WC, KPZL/R | 1143 | | | | | |
| Noxia B | BB, PZ | 898 | | | | | |
| | WC, KPZL/R | 1143 | | | | | |
| Noxia B-DK | | 542 | | | | | |



Polo-DK

POLO

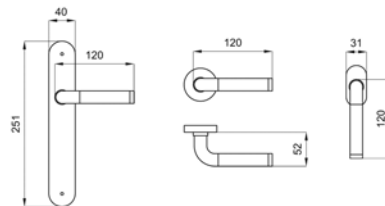

Polo-R (CNS)



Polo



CCS



CNS

Typ povrchové úpravy

| | | CCS | CNS | | | | | |
|---------|------------|------|------|--|--|--|--|--|
| Polo-R | BB, PZ | 822 | 910 | | | | | |
| | WC, KPZL/R | 1043 | 1132 | | | | | |
| Polo | BB, PZ | 822 | 910 | | | | | |
| | WC, KPZL/R | 1043 | 1132 | | | | | |
| Polo-DK | | 562 | 613 | | | | | |





Lorena-R (OGR)



Lorena-DK



Lorena

LORENA

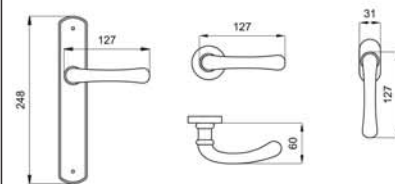

OLV



OGR



| | | Typ povrchové úpravy | | | | | | |
|-----------|------------|----------------------|------|------|--|--|--|--|
| | | OLS | OGR | OLV | | | | |
| Lorena-R | BB, PZ | x | 995 | 995 | | | | |
| | WC, KPZL/R | x | 1148 | 1148 | | | | |
| Lorena | BB, PZ | 845 | 845 | x | | | | |
| | WC, KPZL/R | 998 | 998 | x | | | | |
| Lorena-DK | | x | 425 | 425 | | | | |



Carola-DK

CAROLA

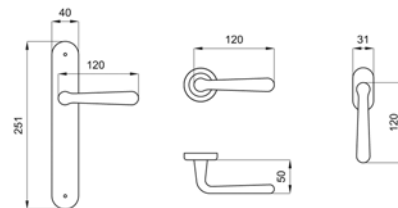

Carola-R (OCS)



Carola



OLV



OCS



OC



| | | Typ povrchové úpravy | | | | | | | |
|-----------|------------|----------------------|-----|------|------|------|--|--|--|
| | | OLV | OGR | OC | OCS | ONS | | | |
| Carola-R | BB, PZ | 632 | 632 | 789 | 789 | 906 | | | |
| | WC, KPZL/R | 820 | 820 | 1027 | 1027 | 1175 | | | |
| Carola | BB, PZ | 632 | 632 | 789 | 789 | 906 | | | |
| | WC, KPZL/R | 820 | 820 | 1027 | 1027 | 1175 | | | |
| Carola-DK | | 538 | 538 | 592 | 592 | 619 | | | |



Wing-R (ONS)



Wing-DK



Wing

WING

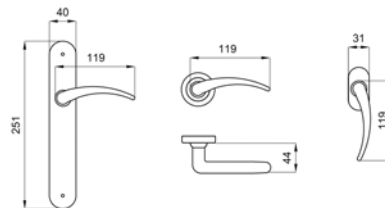

OLV



OC



OGR

Typ povrchové úpravy

| | | OLV | OGR | OC | OCS | ONS | | | |
|---------|------------|-----|-----|-----|-----|------|--|--|--|
| Wing-R | BB, PZ | 550 | 550 | 631 | 631 | 783 | | | |
| | WC, KPZL/R | 743 | 743 | 862 | 862 | 1044 | | | |
| Wing | BB, PZ | 550 | 550 | 631 | 631 | 783 | | | |
| | WC, KPZL/R | 743 | 743 | 862 | 862 | 1044 | | | |
| Wing-DK | | 350 | 350 | 385 | 385 | 420 | | | |



OVALE



Ovale-R (OC)



Ovale-OR



OLV



OGR



OC



OCS



| | | Typ povrchové úpravy | | | | | | | |
|----------|--------|----------------------|------|------|------|--|--|--|--|
| | | OLV | OGR | OC | OCS | | | | |
| Ovale-R | BB, PZ | 1199 | 1199 | 1311 | 1311 | | | | |
| | WC | 1408 | 1408 | 1578 | 1578 | | | | |
| Ovale-OR | BB, PZ | x | x | x | 1311 | | | | |
| | WC | x | x | x | 1578 | | | | |



Daniela-DK

DANIELA

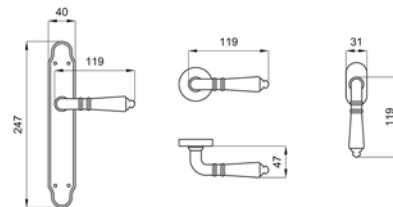

Daniela-R (AF)



Daniela



OLV



OGR



FAN



AF

Typ povrchové úpravy

| | | OLV | OGR | FAN | AF | | | | |
|------------|------------|-----|-----|------|-----|--|--|--|--|
| Daniela-R | BB, PZ | 799 | 799 | 959 | 799 | | | | |
| | WC, KPZL/R | 952 | 952 | 1112 | 952 | | | | |
| Daniela | BB, PZ | 799 | 799 | 959 | 799 | | | | |
| | WC, KPZL/R | 952 | 952 | 1112 | 952 | | | | |
| Daniela-DK | | 365 | 365 | 420 | 365 | | | | |



Kristina-R (OGR)



Kristina-DK



Kristina

KRISTINA

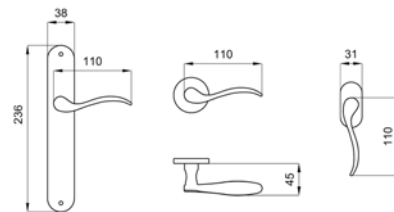

OLV



OS



OC



OCS



| | | Typ povrchové úpravy | | | | | | |
|-------------|------------|----------------------|-----|-----|-----|-----|--|--|
| | | OLV | OS | OGR | OC | OCS | | |
| Kristina-R | BB, PZ | 428 | 428 | 428 | 644 | 644 | | |
| | WC, KPZL/R | 582 | 582 | 582 | 796 | 796 | | |
| Kristina | BB, PZ | 428 | 428 | 428 | 644 | 644 | | |
| | WC, KPZL/R | 582 | 582 | 582 | 796 | 796 | | |
| Kristina-DK | | 354 | 354 | 354 | 389 | 389 | | |



Laura-R (OGR)



Laura-DK

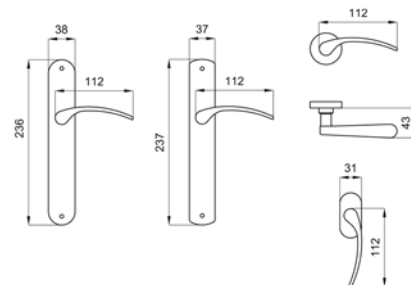

LAURA



Laura



Laura B



OLV



OS



OC



OCS



| | | Typ povrchové úpravy | | | | | | | |
|----------------|------------|----------------------|-----|-----|-----|-----|--|--|--|
| | | OLV | OS | OGR | OC | OCS | | | |
| Laura-R | BB, PZ | 399 | 399 | 399 | 494 | 494 | | | |
| | WC, KPZL/R | 550 | 550 | 550 | 688 | 688 | | | |
| Laura, Laura B | BB, PZ | 399 | 399 | 399 | 494 | 494 | | | |
| | WC, KPZL/R | 550 | 550 | 550 | 688 | 688 | | | |
| Laura-DK | | 349 | 349 | 349 | 396 | 396 | | | |



Prelude (OC)



Prelude-DK



Prelude-R

PRELUDE

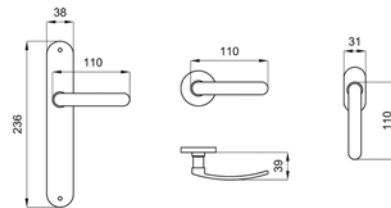

OLV



OS



OGR



OCS



| | | Typ povrchové úpravy | | | | | | | |
|------------|------------|----------------------|-----|-----|-----|-----|--|--|--|
| | | OLV | OS | OGR | OC | OCS | | | |
| Prelude-R | BB, PZ | 382 | 382 | 382 | 597 | 597 | | | |
| | WC, KPZL/R | 534 | 534 | 534 | 750 | 750 | | | |
| Prelude | BB, PZ | 382 | 382 | 382 | 597 | 597 | | | |
| | WC, KPZL/R | 534 | 534 | 534 | 750 | 750 | | | |
| Prelude-DK | | 345 | 345 | 345 | 390 | 390 | | | |

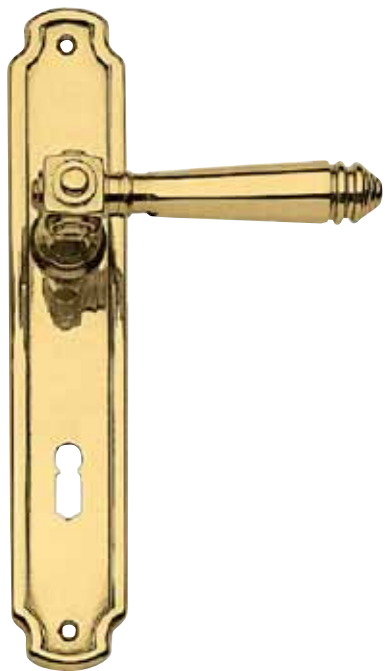

Katy (OLV)



Katy-DK



Katy-R

KATY

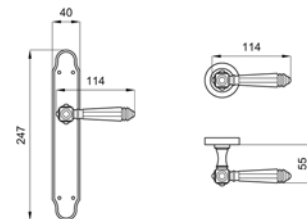

OLV



OGR

Typ povrchové úpravy

| | | OLV | OGR | | | | | |
|---------|------------|------|------|--|--|--|--|--|
| Katy-R | BB, PZ | 1128 | 1128 | | | | | |
| | WC, KPZL/R | 1338 | 1338 | | | | | |
| Katy | BB, PZ | 873 | 873 | | | | | |
| | WC, KPZL/R | 1083 | 1083 | | | | | |
| Katy-DK | | 417 | 417 | | | | | |





Beauty-R (SIL)



Beauty-DK

BEAUTY

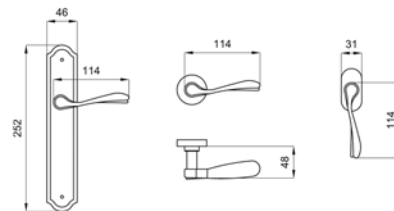

Beauty



OLV



OGR



| | | Typ povrchové úpravy | | | | | | |
|-----------|------------|----------------------|------|------|--|--|--|--|
| | | OLV | OGR | SIL | | | | |
| Beauty-R | BB, PZ | 1132 | 1132 | 1358 | | | | |
| | WC, KPZL/R | 1285 | 1285 | 1511 | | | | |
| Beauty | BB, PZ | 957 | 957 | 1107 | | | | |
| | WC, KPZL/R | 1110 | 1110 | 1260 | | | | |
| Beauty-DK | | 472 | 472 | 542 | | | | |



Doria

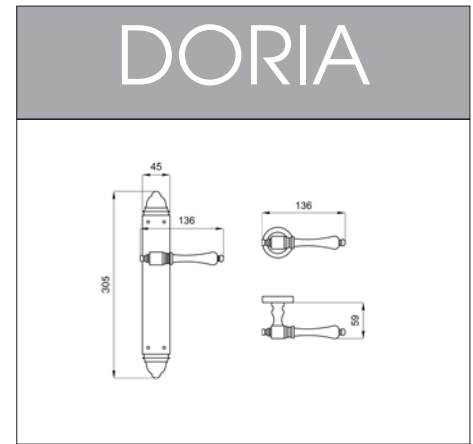

DORIA



| | | Typ povrchové úpravy | | | | | | |
|-------|------------|----------------------|-----|----|--|--|--|--|
| | | OLV | OGR | AF | | | | |
| Doria | BB, PZ | | | | | | | |
| | WC, KPZL/R | | | | | | | |

LARA



Lara (OBS)

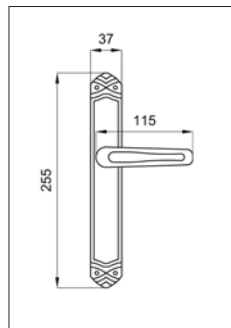

Typ povrchové úpravy

| | | OBS | | |
|------|--------|-----|--|--|
| Lara | BB, PZ | 374 | | |
| | WC | 584 | | |

SERENA



Serena (OLV)

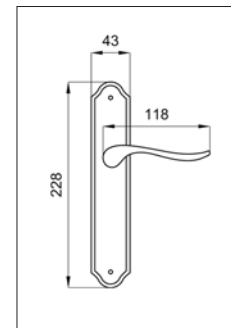

Typ povrchové úpravy

| | | OLV | OGR | |
|--------|------------|-----|-----|--|
| Serena | BB, PZ | 758 | 758 | |
| | WC, KPZL/R | 968 | 968 | |

PAPERINO

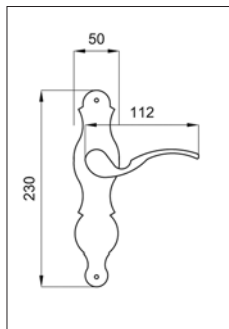
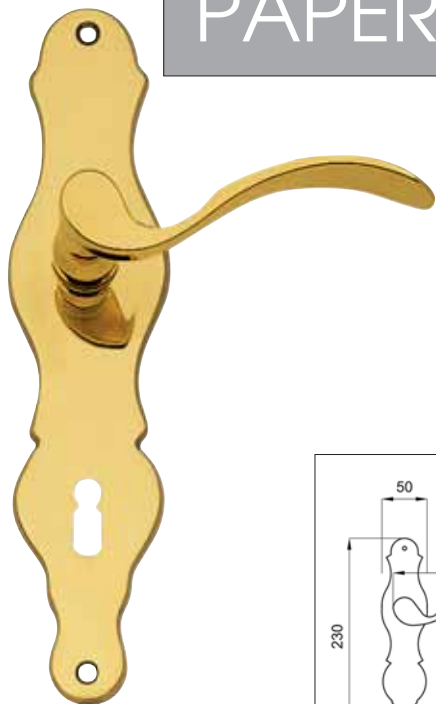

Paperino (OLV)



Typ povrchové úpravy

| | | OLV | OGR | |
|----------|------------|-----|-----|--|
| Paperino | BB, PZ | 561 | 561 | |
| | WC, KPZL/R | 771 | 771 | |

PALERMO

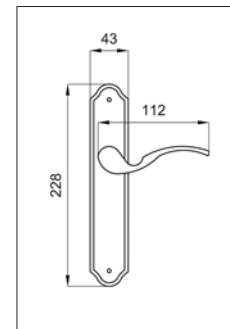

Palermo (OLV)



Typ povrchové úpravy

| | | OLV | OGR | |
|---------|------------|-----|-----|--|
| Palermo | BB, PZ | 509 | 509 | |
| | WC, KPZL/R | 719 | 719 | |

- 
- Madla
 - Kování na francouzská okna
 - Koule
 - Zvonky
 - Klepadla
 - Mušle a zámky na posuvné dveře
 - Dveřní zarážky
 - Držáky zábradlí
 - Vhozy na dopisy
 - Rozety
 - Bezpečnostní rozety

martinelli
HANDLES WITH CARE

LATINA



Latina 300
(OGH)

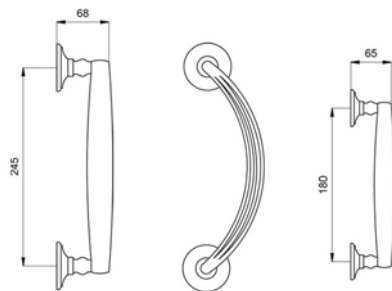
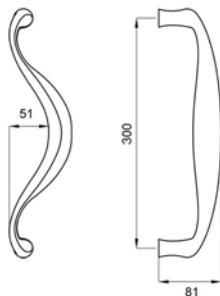

BEVERLY



Beverly 245
(OLV)



Beverly 180
(OGR)

| LATINA | OLV | BSS | OGH | OC | OCS | ONS | PVD | PVD INOX |
|-----------------|------|------|------|------|------|------|------|----------|
| Madlo 300 (kus) | 1823 | 2005 | 2005 | 2005 | 2005 | 2159 | 2498 | 2498 |
| Madlo 300 (pár) | 3645 | 4010 | 4010 | 4010 | 4010 | 4318 | 4995 | 4995 |

| BEVERLY | OLV | OS | OGH | OGR | SIL | PVD | PVD INOX |
|-----------------|------|------|------|------|------|------|----------|
| Madlo 245 (kus) | 2069 | 2069 | 2069 | 2275 | 2379 | 2898 | 2898 |
| Madlo 245 (pár) | 4137 | 4137 | 4137 | 4550 | 4757 | 5795 | 5795 |
| Madlo 180 (kus) | 1947 | 1947 | 1947 | 2142 | 2239 | 2726 | 2726 |
| Madlo 180 (pár) | 3894 | 3894 | 3894 | 4283 | 4478 | 5452 | 5452 |

ONLY



Only 200
(OC)

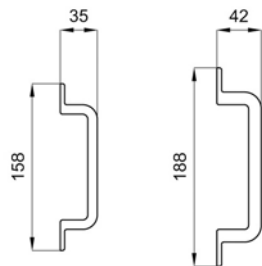

ELENA



Beverly 188
(OC)

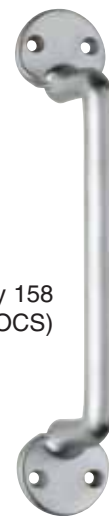

Beverly 158
(OCS)

| ONLY | OLV | OS | OGR | OC | OCS | ONS |
|-----------------|------|------|------|------|------|------|
| Madlo 200 (kus) | 440 | 440 | 440 | 483 | 483 | 527 |
| Madlo 200 (pár) | 1029 | 1029 | 1029 | 1132 | 1132 | 1235 |
| ELENA | OLV | OS | OGR | OC | OCS | ONS |
| Madlo 188 (kus) | 299 | 299 | 299 | 354 | 354 | 421 |
| Madlo 158 (kus) | 210 | 210 | 210 | 244 | 244 | 311 |

ONDA



Onda 190
(OLV)

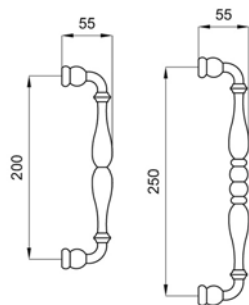
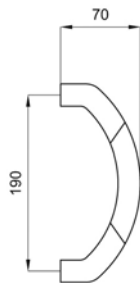

LIRICA



Lirica 200
(OLV)



Lirica 250
(OGR)

| ONDA | OLV | OGR | PVD | PVD INOX |
|-----------------|------|------|------|----------|
| Madlo 190 (kus) | 1401 | 1401 | 1965 | 1965 |
| Madlo 190 (pár) | 2802 | 2802 | 3929 | 3929 |

| LIRICA | OLV | OGR | OGH | BSS |
|-----------------|------|------|------|------|
| Madlo 250 (kus) | 1204 | 1204 | 1350 | 1350 |
| Madlo 250 (pár) | 2408 | 2408 | 2700 | 2700 |
| Madlo 200 (kus) | 1096 | 1096 | 1225 | 1225 |
| Madlo 200 (pár) | 2192 | 2192 | 2450 | 2450 |

KATY



Katy 185
(OLV)

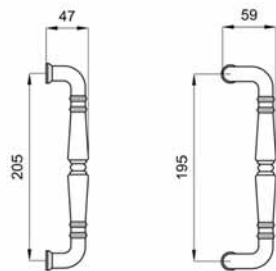
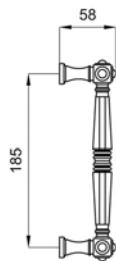

DANIELA



Daniela „L“
195 (AF)



Daniela
205 (FAN)

| KATY | OLV | OGR |
|-----------------|------|------|
| Madlo 185 (kus) | 888 | 888 |
| Madlo 185 (pár) | 1776 | 1776 |

| DANIELA | OLV | OGR | AF | FAN |
|---------------------|------|------|------|------|
| Madlo „L“ 195 (kus) | 888 | 888 | 888 | 1021 |
| Madlo „L“ 195 (pár) | 1776 | 1776 | 1776 | 2042 |
| Madlo 205 (kus) | 777 | 777 | 777 | 934 |
| Madlo 205 (pár) | 1554 | 1554 | 1554 | 1868 |

SABINA



Sabina 190
(OGR)

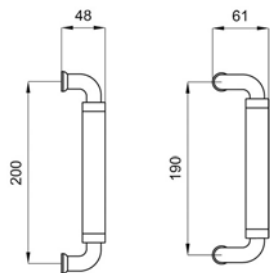
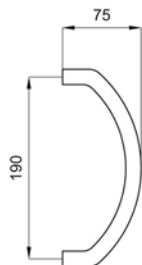

SARA



Sara „L“
190 (OLS)



Sara 200
(OLS)

| SABINA | OLV | OS | OOR | OC | OCS | ONS |
|-----------------|------|------|------|------|------|------|
| Madlo 190 (kus) | 777 | 777 | 777 | 888 | 888 | 1088 |
| Madlo 190 (pár) | 1554 | 1554 | 1554 | 1776 | 1776 | 2176 |

| SARA | OLS | CCS |
|---------------------|------|------|
| Madlo „L“ 190 (kus) | 976 | 1088 |
| Madlo „L“ 190 (pár) | 1952 | 2176 |
| Madlo 200 (ks) | 866 | 976 |
| Madlo 200 (pár) | 1732 | 1952 |

KOVÁNÍ NA FRANCOUZSKÁ OKNA POSUVNÉ BALKONOVÉ DVEŘE

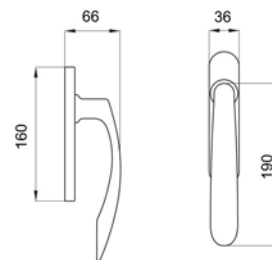
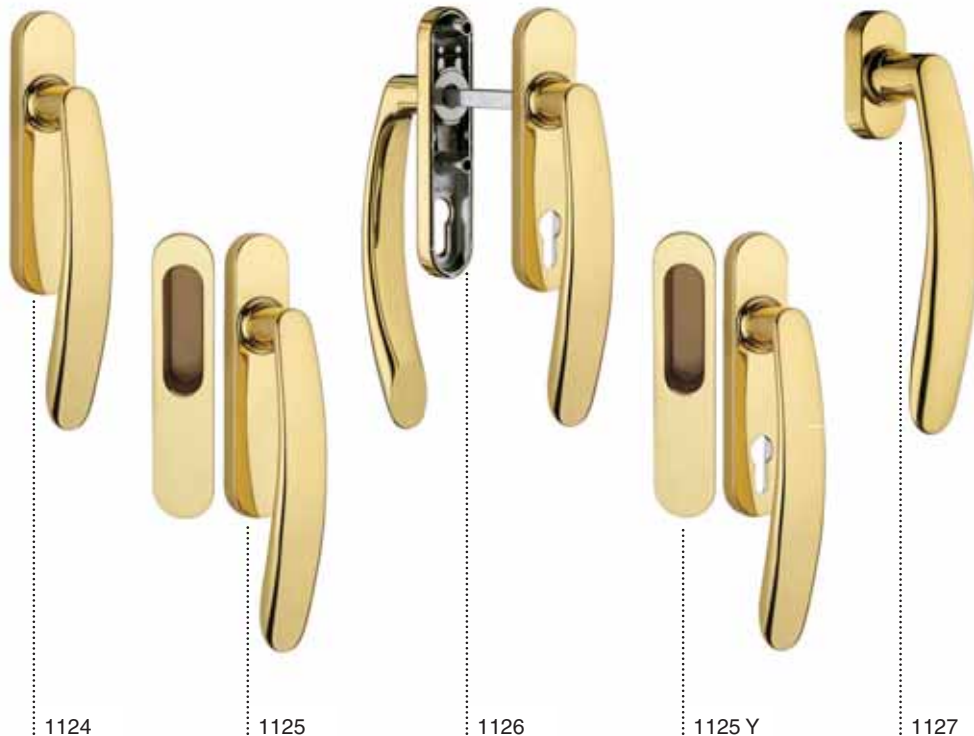

martinelli
ITALY

Typ povrchové úpravy

| | | OLV | OS | OGR | OC | OCS | ONS | PVD | PVD INOX |
|---------------|-----|------|------|------|------|------|------|------|----------|
| 1124 | kus | 1539 | 1539 | 1539 | 1685 | 1685 | 1831 | 2270 | 2270 |
| 1125 | pár | 1823 | 1823 | 1823 | 2005 | 2005 | 2187 | 2790 | 2790 |
| 1125 Y | pár | 1823 | 1823 | 1823 | 2005 | 2005 | 2187 | 2790 | 2790 |
| 1126 | pár | 3366 | 3366 | 3366 | 3702 | 3702 | 4039 | 5090 | 5090 |
| 1127 | kus | 1337 | 1337 | 1337 | 1472 | 1472 | 1604 | 2086 | 2086 |

EASY



Koule pevná (OCS)



Koule pevná (OC)



Koule pevná (OLV)

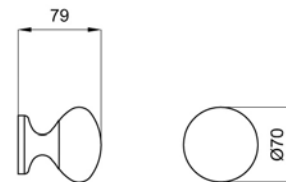

martinelli
ITALY

Typ povrchové úpravy

| | | OLV | OS | OGR | OC | OCS | ONS |
|-------------|-----|-----|-----|-----|-----|-----|-----|
| Koule pevná | kus | 607 | 607 | 607 | 699 | 699 | 911 |

SFERA



Koule pevná (OCS)



Koule otočná (OLV)

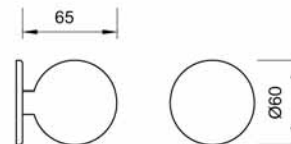

martinelli
SERRAVALLO

Typ povrchové úpravy

| | | OLV | OGR | OC | OCS | ONS |
|--------------|-----|-----|-----|------|------|------|
| Koule pevná | kus | 442 | 442 | 538 | 538 | 563 |
| Koule otočná | pár | 888 | 888 | 1006 | 1006 | 1124 |

DIAMANTE



Koule pevná (OLV)



Koule otočná (OLV)

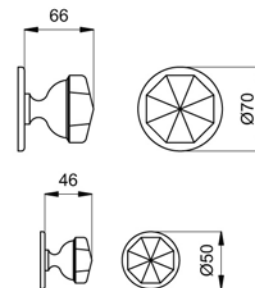

martinelli
ITALY

Typ povrchové úpravy

| | | OLV | OGR | AF | FAN |
|--------------|-----|-----|-----|-----|-----|
| Koule pevná | kus | 397 | 397 | 397 | 476 |
| Koule otočná | pár | 794 | 794 | 794 | 978 |

GEORGIAN



Koule pevná (OLV)



Koule otočná (OLV)

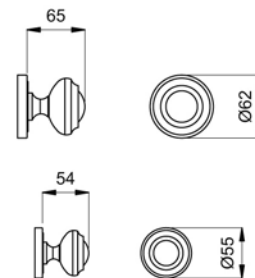

martinelli
ITALY

Typ povrchové úpravy

| | | OLV | OGR | | |
|--------------|-----|-----|-----|--|--|
| Koule pevná | kus | 374 | 374 | | |
| Koule otočná | pár | 748 | 748 | | |

VICTORIAN



Koule pevná (OCS)



Koule otočná (OLV)

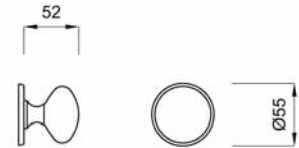

martinelli
ITALY

| | | Typ povrchové úpravy | | | | | |
|--------------|-----|----------------------|-----|-----|-----|-----|-----|
| | | OLV | OS | OGR | OC | OCS | ONS |
| Koule pevná | kus | 329 | 329 | 329 | 389 | 389 | 479 |
| Koule otočná | pár | 613 | 613 | 613 | 726 | 726 | 899 |

MARGHERITA



Koule pevná (OGR)



Koule otočná (OGR)

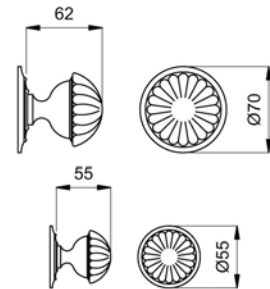

martinelli
ITALY

Typ povrchové úpravy

| | | OLV | OGR | | |
|--------------|-----|-----|-----|--|--|
| Koule pevná | kus | 442 | 442 | | |
| Koule otočná | pár | 794 | 794 | | |



Klepadlo Leone (OLV)

LEONE

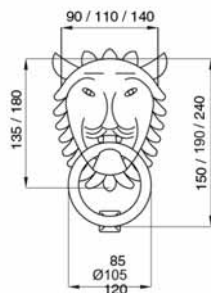

Zvonek Leone (OLV)



Zvonek Oval 60x40 mm (OLV)



Zvonek Cometa ø55 mm (OLV)

ZVONKY

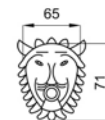

martinelli
SPECIAL METAL FINISHES

Typ povrchové úpravy

| | | OLV | OGR | | |
|-------------------|-----|------|------|--|--|
| Malé (90x50) | kus | 934 | 934 | | |
| Střední (110x190) | kus | 1052 | 1052 | | |
| Velké (140x240) | kus | 1168 | 1168 | | |

martinelli
SPECIAL METAL FINISHES

Typ povrchové úpravy

| | | OLV | OGR | OC | OCS |
|--------|----|-----|-----|-----|-----|
| LEONE | ks | 280 | 280 | × | × |
| OVAL | ks | 194 | 194 | × | × |
| COMETA | ks | 267 | 267 | 320 | 320 |



BAROCCO

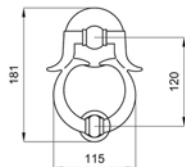

Klepadlo Barocco (OLV)

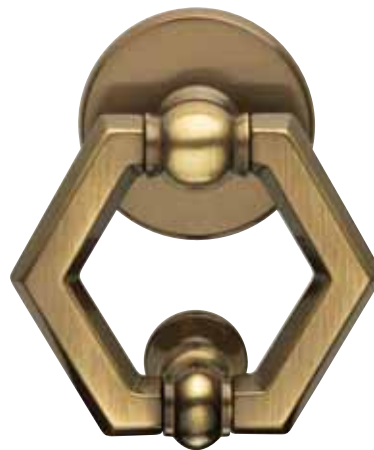

ESAGONO

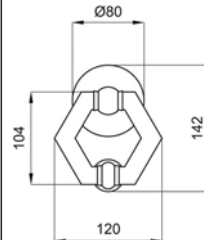

Klepadlo Esagono (OGR)



| | | Typ povrchové úpravy | | | |
|---------|-----|----------------------|------|--|--|
| | | OLV | OGR | | |
| BAROCCO | kus | 1233 | 1233 | | |
| ESAGONO | kus | 1543 | 1543 | | |



AMERICA

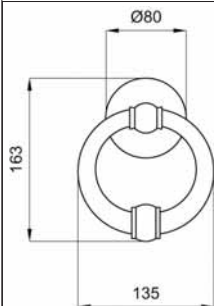

Klepadlo America (OLV)



ANELLO

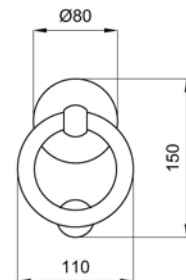

Klepadlo Anello (OLV)



| | | Typ povrchové úpravy | | | |
|---------|-----|----------------------|------|--|--|
| | | OLV | OGR | | |
| AMERICA | kus | 2057 | 2057 | | |
| ANELLO | kus | 1215 | 1215 | | |



Klepadlo Victorian (OLV)

VICTORIAN

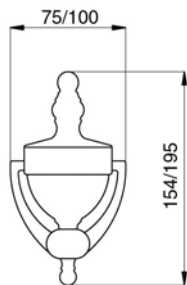

Klepadlo Georgian (OLV)

GEORGIAN

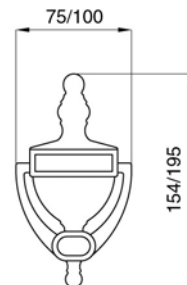

Typ povrchové úpravy

| | | OLV | OGR | | |
|-----------------|-----------|-----|-----|--|--|
| VICTORIAN velké | (100×195) | 497 | 497 | | |
| VICTORIAN malé | (75×154) | 373 | 373 | | |
| GEORGIAN malé | (100×195) | 497 | 497 | | |
| GEORGIAN malé | (75×154) | 373 | 373 | | |



SE 105

Zámek SE 105 na posuvné dveře



| | | |
|--------------|-----|-----|
| Zámek SE 105 | OLV | 275 |
| | OGR | 275 |
| | OC | 316 |
| | OCS | 316 |
| | ONS | 330 |

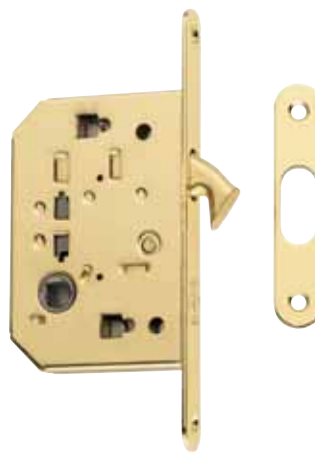

SE 106

Zámek SE106 na posuvné dveře



| | | |
|--------------|-----|-----|
| Zámek SE 106 | OLV | 237 |
| | OGR | 237 |
| | OC | 272 |
| | OCS | 272 |
| | ONS | 284 |

MUŠLE

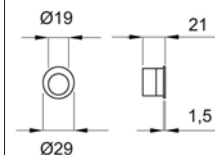

Úchytka do čela dveří (OLV)

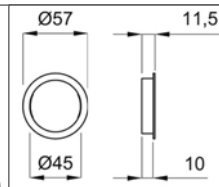

Dveřní mušle kruhová BO (OLV)

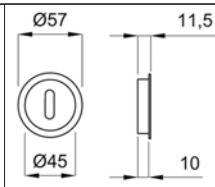

Dveř. mušle kruhová na posuv. dveře BB (OLV)

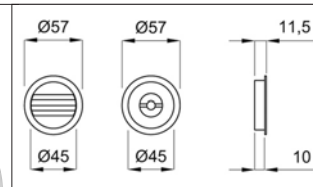

Dveřní mušle kruhová – WC sada (OLV)

martinelli

Typ povrchové úpravy

| | | OLV | OGR | OC | OCS | ONS | | | |
|---------------|---------|-----|-----|-----|-----|-----|--|--|--|
| Čelní úchytka | kus | 63 | 63 | 75 | 75 | 84 | | | |
| Mušle BO | kus | 118 | 118 | 141 | 141 | 153 | | | |
| Mušle BB | kus | 118 | 118 | 141 | 141 | 153 | | | |
| Mušle WC | WC sada | 438 | 438 | 526 | 526 | 569 | | | |



Mušle Rettangolo

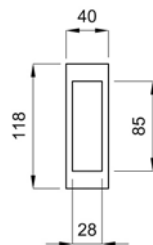

RETTANGOLO



Mušle Daniela

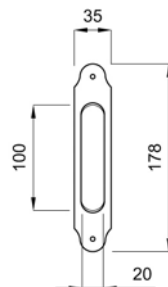

DANIELA



| | | Typ povrchové úpravy | | | | | | | |
|---------------------|----|----------------------|-----|-----|-----|-----|-----|--|--|
| | | OLV | OS | OGR | OC | OCS | ONS | | |
| Mušle RETTANGOLO | BO | 189 | 189 | 189 | 235 | 235 | 253 | | |
| | BB | 189 | 189 | 189 | 235 | 235 | 253 | | |
| Mušle DANIELA | BO | 189 | x | 189 | x | x | x | | |
| | BB | 189 | x | 189 | x | x | x | | |



Mušle Lorena

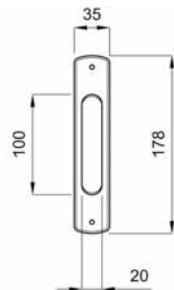

LORENA



Mušle Noxia

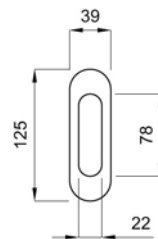

NOXIA



| | | Typ povrchové úpravy | | | | | | | |
|-----------------|----|----------------------|-----|-----|-----|-----|-----|--|--|
| | | OLV | OS | OGR | OC | OCS | ONS | | |
| Mušle LORENA | BO | 189 | × | 189 | 235 | 235 | 253 | | |
| | BB | 189 | × | 189 | 235 | 235 | 253 | | |
| Mušle NOXIA | BO | 222 | 222 | 222 | 268 | 268 | 315 | | |
| | BB | 222 | 222 | 222 | 268 | 268 | 315 | | |

DVEŘNÍ ZARÁŽKY



Zarážka šneková 2264 (ø45mm)



Zarážka cylindrická 2265 (29x45 mm)

DRŽÁKY ZÁBRADLÍ



Držák zábradlí 2263



Držák zábradlí 22580



Držák zábradlí 22581



| | | Typ povrchové úpravy | | | | | | | |
|--------------|-----|----------------------|-----|-----|-----|-----|--|--|--|
| | | OLV | OGR | OC | OCS | ONS | | | |
| Zarážka 2264 | kus | 104 | 104 | 127 | 127 | 143 | | | |
| Zarážka 2265 | kus | 187 | 187 | 209 | 209 | 244 | | | |
| Držák 2263 | kus | 313 | 313 | x | x | x | | | |
| Držák 22580 | kus | 224 | 224 | 336 | 336 | 365 | | | |
| Držák 22581 | kus | 224 | 224 | 336 | 336 | 365 | | | |

DOPISNÍ VHOZY

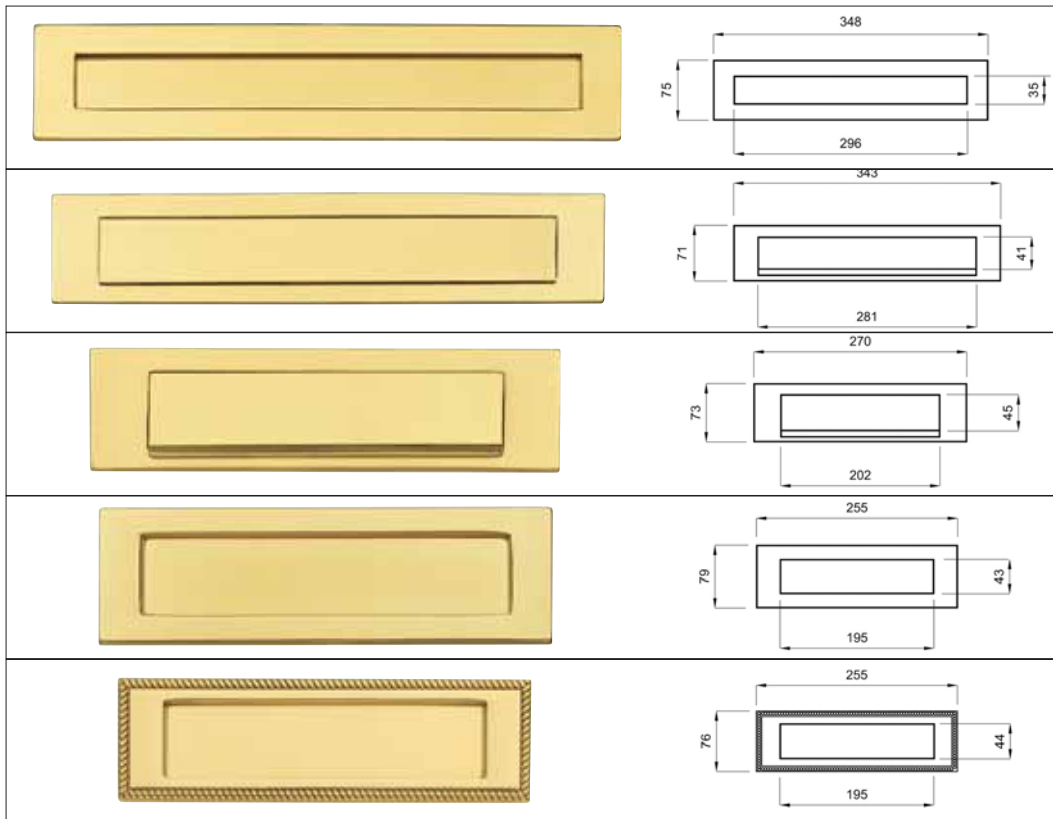

Typ povrchové úpravy

OLV OGR

| | | |
|-----------|-----|-----|
| Vhoz 2210 | 607 | 607 |
| Vhoz 2211 | 607 | 607 |
| Vhoz 2212 | 538 | 538 |
| Vhoz 2213 | 538 | 538 |
| Vhoz 2216 | 561 | 561 |

ROZETY



1



2



3



4



5



6



7



8

martinelli
INNOVATION IN DESIGN

| | Typ povrchové úpravy | | | | | |
|------------------------------------|----------------------|----|------|-----|-----|-----|
| | OLV | OS | OGR | OC | OCS | ONS |
| Sada bezpeč. rozety bez krytky (1) | 839 | × | 839 | 887 | 887 | × |
| Sada bezpeč. rozety s krytkou (2) | 1361 | × | 1361 | 141 | 141 | × |
| Rozeta plastová 52 mm BB (3) | 77 | 77 | 77 | 89 | 89 | 109 |
| Rozeta plastová 52 mm PZ (4) | 77 | 77 | 77 | 89 | 89 | 109 |
| Rozeta čtvercová 50 mm BB (5) | 85 | 85 | 85 | 101 | 101 | 121 |
| Rozeta čtvercová 50 mm PZ (6) | 85 | 85 | 85 | 101 | 101 | 121 |
| Rozeta oválná 30x60 mm BB (7) | 77 | 77 | 77 | 89 | 89 | 109 |
| Rozeta oválná 30x60 mm PZ (8) | 77 | 77 | 77 | 89 | 89 | 109 |

UNO

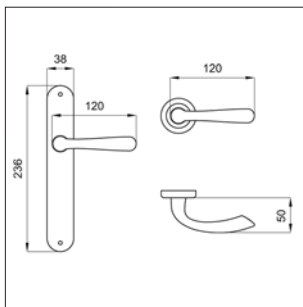

Dveřní klika se štítem

DUE

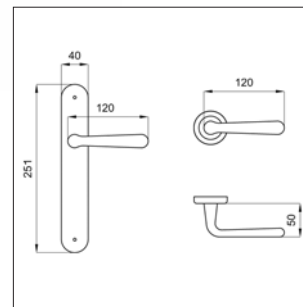

Dveřní klika se štítem



| | | Typ povrchové úpravy | | |
|-------|-----------|----------------------|-----|--|
| | | OC | ONS | |
| UNO | BB, PZ | 436 | 436 | |
| | WC, KL-KO | 665 | 665 | |
| UNO-R | BB, PZ | 436 | 436 | |
| | WC, KL-KO | 665 | 665 | |



| | | Typ povrchové úpravy | | |
|-------|-----------|----------------------|-----|--|
| | | OC | ONS | |
| DUE | BB, PZ | 416 | 416 | |
| | WC, KL-KO | 645 | 645 | |
| DUE-R | BB, PZ | 416 | 416 | |
| | WC, KL-KO | 645 | 645 | |



- Nerezové kliky
- Madla
- Koule
- Mušle
- Dveřní zarážky
- Držáky zábradlí
- Vhozy na dopisy
- Rozety

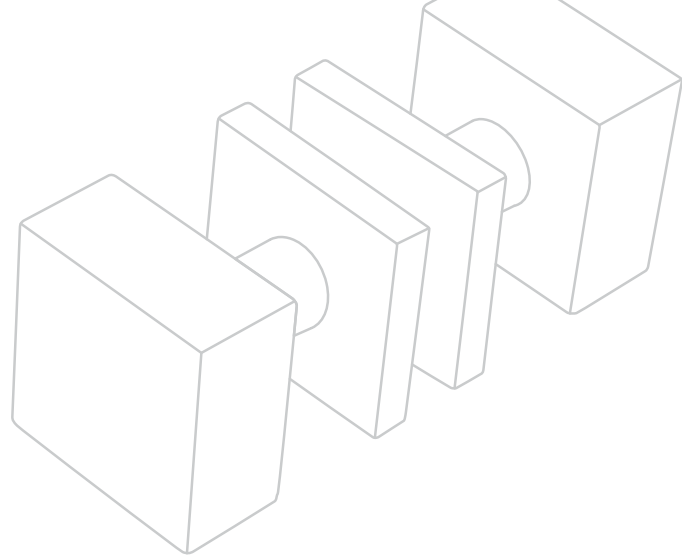

martinelli
HANDLES WITH CARE



LOOK ME



Dveřní klika s kruhovou rozetou

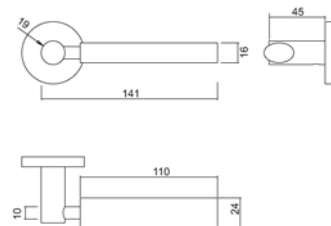

Okenní klička na eurookna



OLV



OS



OGR



OCS



| | | Typ povrchové úpravy | | | | |
|-----------|------------|----------------------|-------------|------------|-------------|--|
| | | NEREZ ORANGE | NEREZ GREEN | NEREZ BLUE | NEREZ BLACK | |
| LOOK ME-R | BB, PZ | 1056 | 1056 | 1056 | 1056 | |
| | WC, KPZL/R | 1170 | 1170 | 1170 | 1170 | |
| LOOK ME | DK | 605 | 605 | 605 | 605 | |



Dveřní klika se čtvercovou rozetou



Okenní klička na eurookna

METRIC

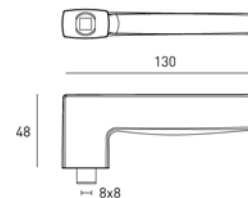

Dveřní klika se štítem



Typ povrchové úpravy

NEREZ

| | | | |
|-----------|------------|------|--|
| METRIC | BB, PZ | 1233 | |
| | WC, KPZL/R | 1475 | |
| METRIC-HR | BB, PZ | 1245 | |
| | WC, KPZL/R | 1402 | |
| METRIC | DK | 544 | |

DUO



Dveřní klika se čtvercovou rozetou

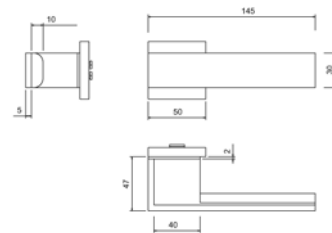

martinelli
SERRAVALLO S.p.A. - Italy

Typ povrchové úpravy

NEREZ

DUO-HR
BB, PZ
WC

1994
2151



Dveřní klika se čtvercovou rozetou



Okenní klička na eurookna

QUADRO

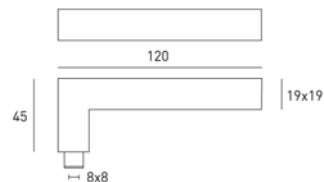

Dveřní klika se štítem



Typ povrchové úpravy

NEREZ

| | | | |
|-----------|------------|------|--|
| QUADRO | BB, PZ | 1064 | |
| | WC, KPZL/R | 1306 | |
| QUADRO-HR | BB, PZ | 1124 | |
| | WC, KPZL/R | 1281 | |
| QUADRO | DK | 460 | |



Dveřní klika se čtvercovou rozetou



Okenní klička na eurookna



Dveřní klika se štítem

NEXT

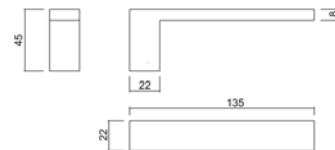

martinelli
ITALY

Typ povrchové úpravy

NEREZ

| | | | |
|---------|------------|------|--|
| NEXT | BB, PZ | 1306 | |
| | WC, KPZL/R | 1547 | |
| NEXT-HR | BB, PZ | 1221 | |
| | WC, KPZL/R | 1378 | |
| NEXT | DK | 375 | |

LINEAR



Dveřní klika se čtvercovou rozetou



Okenní klička na eurookna

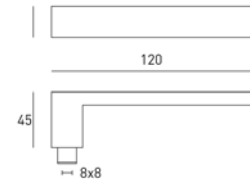

Dveřní klika se štítem



martinelli
TRAVATA S.p.A. - 36010 S. GIACOMO (VI) - ITALIA

Typ povrchové úpravy

NEREZ

| | | | |
|----------|------------|------|--|
| LINEAR | BB, PZ | 895 | |
| | WC, KPZL/R | 1136 | |
| LINEAR-R | BB, PZ | 597 | |
| | WC, KPZL/R | 711 | |

martinelli
TRAVATA S.p.A. - 36010 S. GIACOMO (VI) - ITALIA

Typ povrchové úpravy

NEREZ

| | | | |
|-----------|------------|------|--|
| LINEAR-HR | BB, PZ | 786 | |
| | WC, KPZL/R | 1112 | |
| LINEAR | DK | 375 | |

ATHENA



Dveřní klika se čtvercovou rozetou



Okenní klička na eurookna

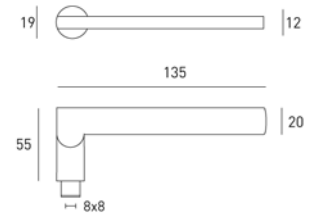

Dveřní klika se štítem



martinelli
TRAVATA S.p.A. - ITALY

Typ povrchové úpravy

NEREZ

| | | | |
|----------|------------|------|--|
| ATHENA | BB, PZ | 1040 | |
| | WC, KPZL/R | 1281 | |
| ATHENA-R | BB, PZ | 742 | |
| | WC, KPZL/R | 856 | |

martinelli
TRAVATA S.p.A. - ITALY

Typ povrchové úpravy

NEREZ

| | | | |
|-----------|------------|------|--|
| ATHENA-OR | BB, PZ | 742 | |
| ATHENA-HR | BB, PZ | 1133 | |
| | WC, KPZL/R | 1290 | |
| ATHENA | DK | 448 | |



Dveřní klika s kruhovou rozetou



Okenní klička na eurookna

MARCO

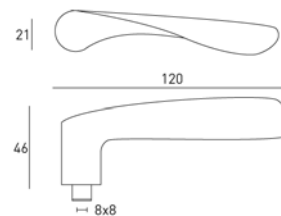

martinelli
PRODOTTI METAL CANTÙ

Typ povrchové úpravy

NEREZ

MARCO-R

BB, PZ

645

WC, KPZL/R

759

MARCO

DK

399



VISION

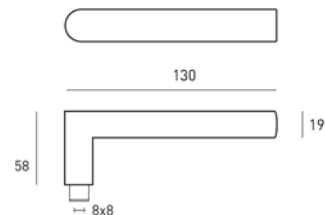

Dveřní klika se štítem



Dveřní klika s kruhovou rozetou



Okenní klička na eurookna



Dveřní klika se štítem



martinelli

Typ povrchové úpravy

NEREZ

| | | | |
|-----------|------------|-----|--|
| VISION | BB, PZ | 750 | |
| | WC, KPZL/R | 991 | |
| VISION-HS | BB, PZ | 750 | |
| | WC, KPZL/R | 991 | |
| VISION | DK | 303 | |

martinelli

Typ povrchové úpravy

NEREZ

| | | | |
|-----------|------------|-----|--|
| VISION-R | BB, PZ | 452 | |
| | WC, KPZL/R | 566 | |
| VISION-OR | BB, PZ | 452 | |
| VISION-HR | BB, PZ | 780 | |
| | WC, KPZL/R | 937 | |



Dveřní klika s kruhovou rozetou



Okenní klička na eurookna



Dveřní klika se štítem

LOFT

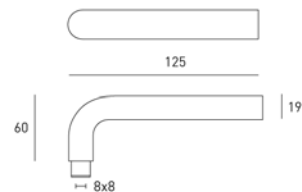

martinelli
SISTEMI PER MANI

Typ povrchové úpravy

NEREZ

| | | | |
|--------|------------|-----|--|
| LOFT | BB, PZ | 689 | |
| | WC, KPZL/R | 931 | |
| LOFT-R | BB, PZ | 392 | |
| | WC, KPZL/R | 506 | |

martinelli
SISTEMI PER MANI

Typ povrchové úpravy

NEREZ

| | | | |
|---------|--------|-----|--|
| LOFT-OR | BB, PZ | 392 | |
| LOFT | DK | 272 | |



Dveřní klika s kruhovou rozetou



Okenní klička na eurookna



Dveřní klika se štítem

UFO

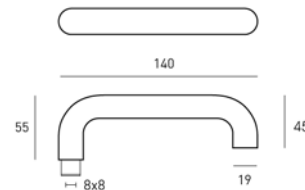

martinelli
ITALY

Typ povrchové úpravy
 NEREZ

| | | | |
|-------|------------|-----|--|
| UFO | BB, PZ | 701 | |
| | WC, KPZL/R | 943 | |
| UFO-R | BB, PZ | 404 | |
| | WC, KPZL/R | 518 | |

martinelli
ITALY

Typ povrchové úpravy
 NEREZ

| | | | |
|--------|--------|-----|--|
| UFO-OR | BB, PZ | 404 | |
| UFO | DK | 278 | |



Dveřní klika s kruhovou rozetou



Okenní klička na eurookna

CARLO

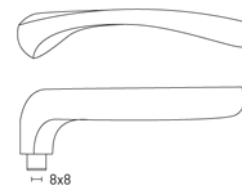

martinelli
PRODUCED WITH CARE

Typ povrchové úpravy

NEREZ

| | |
|---------|------------|
| CARLO-R | BB, PZ |
| | WC, KPZL/R |
| CARLO | DK |

597

711

375



Dveřní klika s kruhovou rozetou



Okenní klička na eurookna



Dveřní klika se štítem

NORD

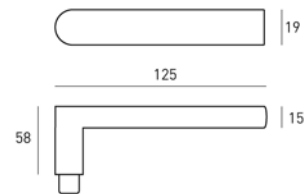

martinelli
TRADING & SERVICE GROUP

Typ povrchové úpravy
 NEREZ

| | | | |
|--------|------------|------|--|
| NORD | BB, PZ | 822 | |
| | WC, KPZL/R | 1064 | |
| NORD-R | BB, PZ | 524 | |
| | WC, KPZL/R | 639 | |

martinelli
TRADING & SERVICE GROUP

Typ povrchové úpravy
 NEREZ

| | | | |
|---------|--------|-----|--|
| NORD-OR | BB, PZ | 524 | |
| NORD | DK | 339 | |



Dveřní klika s kruhovou rozetou



Okenní klička na eurookna



Dveřní klika se štítem

ARCO

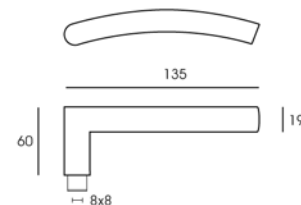

martinelli
TRAVATA DI QUALITÀ ITALIANA

Typ povrchové úpravy
 NEREZ

| | | | |
|--------|------------|-----|--|
| ARCO | BB, PZ | 750 | |
| | WC, KPZL/R | 991 | |
| ARCO-R | BB, PZ | 452 | |
| | WC, KPZL/R | 566 | |

martinelli
TRAVATA DI QUALITÀ ITALIANA

Typ povrchové úpravy
 NEREZ

| | | | |
|---------|--------|-----|--|
| ARCO-OR | BB, PZ | 452 | |
| ARCO | DK | 303 | |



Dveřní klika s kruhovou rozetou



Okenní klička na eurookna

VEGA

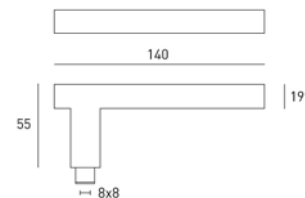

martinelli
PRODUCED IN ITALY

Typ povrchové úpravy

NEREZ

VEGA-R BB, PZ

452

WC, KPZL/R

566

VEGA DK

303

80

7287



Madlo 7287

| Rozměr | Cena/ks |
|-----------|---------|
| 25 × 300 | 933 |
| 25 × 425 | 1153 |
| 25 × 600 | 1221 |
| 30 × 250 | 1153 |
| 30 × 425 | 1390 |
| 30 × 600 | 1628 |
| 30 × 1250 | 2204 |
| 35 × 425 | 1763 |
| 35 × 600 | 2034 |
| 35 × 1250 | 2712 |

7289



Madlo 7289

| Rozměr | Cena/ks |
|----------|---------|
| 25 × 300 | 1085 |
| 30 × 350 | 1356 |

HRANOL



Madlo – hranol



Typ povrchové úpravy

NEREZ

| | | | |
|--------|--------------|-----|--|
| Madlo | pevné (ks) | 481 | |
| QUADRO | otočné (pár) | 848 | |

KOULE



Madlo – koule

martinelli
ITALYAN DESIGN

Typ povrchové úpravy

NEREZ

| | | | |
|-------|--------------|-----|--|
| Koule | pevná (ks) | 255 | |
| EAST | otočná (pár) | 622 | |

VÁLEC



Madlo – válec

martinelli
SILVERLINE HANDLE COMPANY

Typ povrchové úpravy

NEREZ

| | |
|-------|--------------|
| Madlo | pevné (ks) |
| VÁLEC | otočné (pár) |

565

1160

KOULE



Madlo – vyosené koule

martinelli
SPOLEČNOSTI MARTINELLI GROUP

Typ povrchové úpravy

NEREZ

| | | | |
|---------|--------------|-----|--|
| Madlo | pevné (ks) | x | |
| VYOSENÉ | otočné (pár) | 848 | |

MUŠLE



Mušle čtvercová 70 mm



Mušle kruhová \varnothing 70 mm



Mušle čtvercová 50 mm



Mušle kruhová \varnothing 50 mm



Mušle oválná

martinelli
S.p.A. - 19014 - CHIUSANO (PT) - ITALY

Typ povrchové úpravy

NEREZ

| | | | |
|---------|-----------|-----|--|
| ČTVEREC | 70 mm | 162 | |
| ČTVEREC | 50 mm | 102 | |
| KRUH | 70 mm | 111 | |
| KRUH | 50 mm | 88 | |
| OVÁL | 125x39 mm | 163 | |

ZARÁŽKY



Zarážka C806



Zarážka 2130



Zarážka 3120

DRŽÁKY



Držák zábradlí rovný



Držák zábradlí žlábkový

martinelli

Typ povrchové úpravy

NEREZ

| | | | |
|-------------|-------------|-----|--|
| ZARÁŽKA | na zeď C806 | 90 | |
| ZARÁŽKA | 2130 | 92 | |
| ZARÁŽKA | 3120 | 162 | |
| DRŽÁK ZÁBR. | rovný | 291 | |
| DRŽÁK ZÁBR. | žlábkový | 291 | |

DOPISNÍ VHOZY



Dopisní vhoz typ 540



Dopisní vhoz typ 541



Typ povrchové úpravy

NEREZ

| | | | |
|---------------|---------|------|--|
| Dopisní vhozy | typ 540 | 1064 | |
| | typ 541 | 1161 | |

ROZETY



BR kulatá



BB kulatá



BB



BB ovál



BR ovál



PZ



PZ hranatá



PZ ovál



Typ povrchové úpravy

| | OLV | |
|---|-----|--|
| Sada bezpečnostních rozet s krytkou (BR kulatá) | 701 | |
| Sada bezpečnostních rozet oválných (BB kulatá) | 629 | |
| Rozeta kovová 50 mm (BB) | 49 | |
| Rozeta kovová 50 mm (PZ) | 49 | |
| Rozeta oválná 30x60 mm (BB ovál) | 49 | |
| Rozeta oválná 30x60 mm (PZ ovál) | 49 | |
| Rozeta hranatá 52 mm (BB) | 170 | |
| Rozeta hranatá 52 mm (PZ) | 170 | |

- Hliníkové kliky
- Koule
- Koule
- Okenní olivy
- Bezpečnostní kování



martinelli[®]
HANDLES WITH CARE

MONET

Dveřní klika se štítem



Dveřní klika s kruhovou rozetou

UNIVERSAL

Dveřní klika se štítem



Dveřní klika s kruhovou rozetou

martinelli
interior hardware

Typ povrchové úpravy

| | | F1 | F4 | |
|---------|------------|-----|-----|--|
| MONET | BB, PZ | 145 | 145 | |
| | WC, KPZL/R | 195 | 195 | |
| MONET-R | BB, PZ | 155 | 155 | |
| | WC, KPZL/R | 206 | 206 | |

martinelli
interior hardware

Typ povrchové úpravy

| | | F1 | F4 | |
|-------------|------------|-----|-----|--|
| UNIVERSAL | BB, PZ | 148 | 148 | |
| | WC, KPZL/R | 198 | 198 | |
| UNIVERSAL-R | BB, PZ | 158 | 158 | |
| | WC, KPZL/R | 209 | 209 | |



MODUS

Dveřní klika s kruhovou rozetou



Dveřní klika s oválnou rozetou

CORNER

Dveřní klika s kruhovou rozetou



Dveřní klika s oválnou rozetou

martinelli
INNOVATIVE DESIGN

Typ povrchové úpravy

| | | F1 | | |
|----------|------------|-----|--|--|
| MODUS-R | BB, PZ | 198 | | |
| | WC, KPZL/R | 249 | | |
| MODUS-OR | BB, PZ | 251 | | |

martinelli
INNOVATIVE DESIGN

Typ povrchové úpravy

| | | F1 | | |
|-----------|------------|-----|--|--|
| CORNER-R | BB, PZ | 234 | | |
| | WC, KPZL/R | 285 | | |
| CORNER-OR | BB, PZ | 287 | | |



PRAHA

Dveřní klika se štítem



Dveřní klika s kruhovou rozetou

KLASIK

Dveřní klika se štítem



Dveřní klika s kruhovou rozetou

martinelli
interior design

Typ povrchové úpravy

| | | F1 | F4 | |
|---------|------------|-----|-----|--|
| PRAHA | BB, PZ | 159 | 159 | |
| | WC, KPZL/R | 209 | 209 | |
| PRAHA-R | BB, PZ | 169 | 169 | |
| | WC, KPZL/R | 220 | 220 | |

martinelli
interior design

Typ povrchové úpravy

| | | F1 | F4 | |
|----------|------------|-----|-----|--|
| KLASIK | BB, PZ | 258 | 258 | |
| | WC, KPZL/R | 344 | 344 | |
| KLASIK-R | BB, PZ | 289 | 289 | |
| | WC, KPZL/R | 396 | 396 | |



MIRA

Dveřní klika se štítem



Dveřní klika s kruhovou rozetou

SABINA

Dveřní klika se štítem



Dveřní klika s kruhovou rozetou

martinelli

| | | Typ povrchové úpravy | | |
|--------|------------|----------------------|-----|--|
| | | F1 | F4 | |
| MIRA | BB, PZ | 294 | 294 | |
| | WC, KPZL/R | 377 | 377 | |
| MIRA-R | BB, PZ | 287 | 287 | |
| | WC, KPZL/R | 394 | 394 | |

martinelli

| | | Typ povrchové úpravy | | |
|----------|------------|----------------------|-----|--|
| | | F1 | F4 | |
| SABINA | BB, PZ | 279 | 279 | |
| | WC, KPZL/R | 362 | 362 | |
| SABINA-R | BB, PZ | 272 | 272 | |
| | WC, KPZL/R | 379 | 379 | |

SINA

Dveřní klika s kruhovou rozetou



Dveřní klika s oválnou rozetou

SINA

Dveřní klika s kruhovou rozetou



Dveřní klika s kruhovou rozetou

martinelli
ITALY

Typ povrchové úpravy

| | | F1 | F4 | |
|--------|------------|-----|-----|--|
| SINA-R | BB, PZ | 198 | 198 | |
| | WC, KPZL/R | 249 | 249 | |

97

martinelli
ITALY

Typ povrchové úpravy

| | | OC | ONS | |
|--------|------------|-----|-----|--|
| SINA-R | BB, PZ | 247 | 247 | |
| | WC, KPZL/R | 347 | 347 | |



martinelli
PROJEKTOVANÉ A VYROBENÉ V ČESKÉ REPUBLICE

Typ povrchové úpravy

| | F1 | F4 |
|--|-----|-----|
| Koule pevná $\varnothing 50$ mm (1, 2) | 701 | 159 |
| Klika na eurookna (3, 4, 5) | 629 | 89 |
| Okenní půloliva (6, 7) | 49 | 65 |
| Oliva | 49 | 105 |
| Rozvora | 49 | 136 |
| Štít MONET s klikou | 49 | 148 |
| Štít UNIVERSAL s klikou | 170 | 163 |
| Štít PRAHA s klikou | 170 | 177 |



| | Přírodní elox | Bronz elox |
|-----------------------------|---------------|------------|
| Klika/klika | | |
| Madlo/klika | | |
| Přídavná rozeta | | |
| Klika/klika PLUS | | |
| Madlo/klika PLUS | | |
| Přídavná rozeta PLUS | | |



Přírodní elox



Zlatý elox



Bronz



Nerez elox

BEZPEČNOSTNÍ KOVÁNÍ AXA



| | Přírodní elox | Zlatý elox | Bronz | Nerez elox |
|----------------------|---------------|------------|-------|------------|
| Klika/klika | | | | |
| Madlo/klika | | | | |
| Přídavná rozeta | | | | |
| Klika/klika PLUS | | | | |
| Madlo/klika PLUS | | | | |
| Přídavná rozeta PLUS | | | | |



Přírodní elox

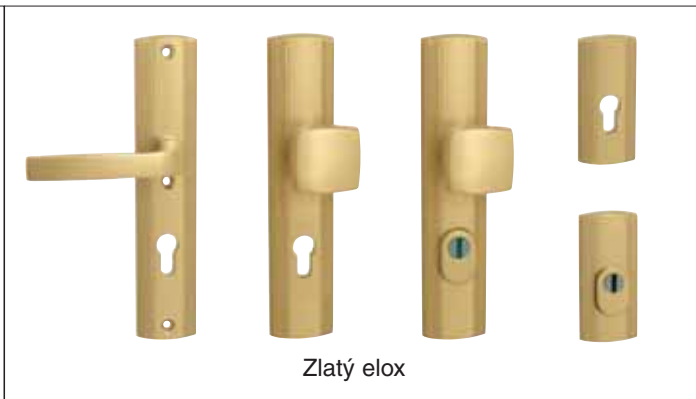

Zlatý elox



Bronz

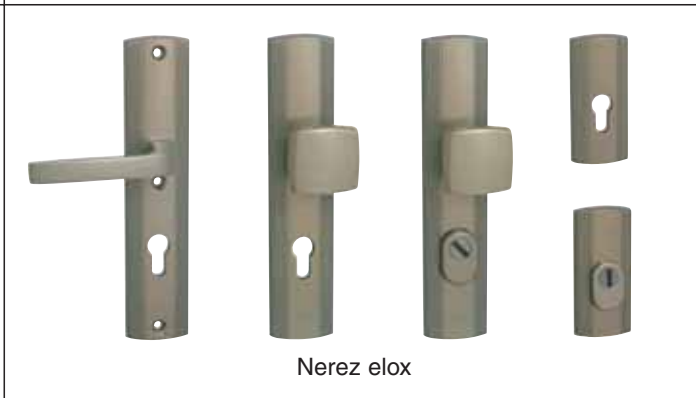

Nerez elox

BEZPEČNOSTNÍ KOVÁNÍ **PRESTIGE**



| | Přírodní elox | Zlatý elox | Bronz | Nerez elox |
|----------------------|---------------|------------|-------|------------|
| Klika/klika | | | | |
| Madlo/klika | | | | |
| Přídavná rozeta | | | | |
| Klika/klika PLUS | | | | |
| Madlo/klika PLUS | | | | |
| Přídavná rozeta PLUS | | | | |

ČÍSLICE



Ozdobné číslice (výška 80 mm)



Typ povrchové úpravy

OLV OGR

Číslice 0–9, 120 mm

202 202

Číslice 0–9, 80 mm

104 104

SKLAPKA

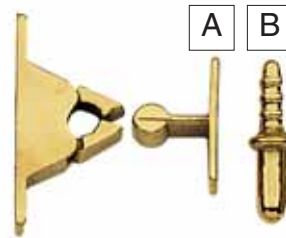

Dveřní sklapka



OLV

Dveřní sklapka + protikus A

95

Dveřní sklapka + protikus B

95

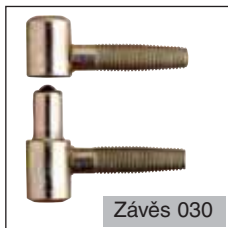

Závěs 030

Dveřní závěs 030

| kód | název | Typ povrchové úpravy | |
|-----------|-----------------------|----------------------|--------|
| | | POZ | ŽL.POZ |
| OCF030130 | Závěs 030/13 mm horní | 5 | 5 |
| OCG030130 | Závěs 030/13 mm dolní | 6 | 6 |
| OCI030130 | Závěs 030/13 mm sada | 11 | 11 |
| OCF030140 | Závěs 030/14 mm horní | 7 | 5 |
| OCG030140 | Závěs 030/14 mm dolní | 8 | 7 |
| OCI030140 | Závěs 030/14 mm sada | 15 | 12 |
| OCF030160 | Závěs 030/16 mm horní | 8 | 7 |
| OCG030160 | Závěs 030/16 mm dolní | 10 | 8 |
| OCI030160 | Závěs 030/16 mm sada | 18 | 15 |



Závěs 100

Dveřní závěs 055

| kód | název | Typ povrchové úpravy | | | | |
|-----------|-----------------------|----------------------|------|-------|--------|----------|
| | | ŽL.POZ | POBR | POMOS | PONIKL | MAT.NIKL |
| OCF055130 | Závěs 055/13 mm horní | 5 | 7 | 7 | 7 | 17 |
| OCG055130 | Závěs 055/13 mm dolní | 6 | 8 | 8 | 8 | 19 |
| OCI055130 | Závěs 055/13 mm sada | 11 | 15 | 15 | 15 | 36 |
| OCF055140 | Závěs 055/14 mm horní | 6 | 7 | 7 | 8 | x |
| OCG055140 | Závěs 055/14 mm dolní | 7 | 9 | 8 | 10 | x |
| OCI055140 | Závěs 030/14 mm sada | 13 | 16 | 15 | 18 | x |
| OCF055160 | Závěs 055/16 mm horní | 9 | 11 | 12 | 10 | x |
| OCG055160 | Závěs 055/16 mm dolní | 10 | 12 | 13 | 13 | x |
| OCI055160 | Závěs 055/16 mm sada | 19 | 23 | 25 | 23 | x |



Závěs 100

Dveřní závěs 100

| kód | název | Typ povrchové úpravy | | |
|-----------|-----------------------|----------------------|-------|--------|
| | | BR.SP. | POMOS | PONIKL |
| OCF100150 | Závěs 100/15 mm horní | 14 | 12 | 12 |
| OCG100150 | Závěs 100/15 mm dolní | 21 | 19 | 18 |
| OCI100150 | Závěs 100/15 mm sada | 35 | 31 | 30 |

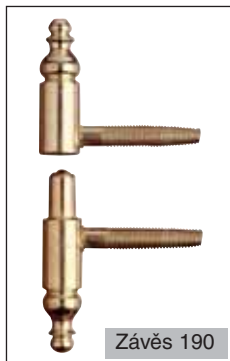

Závěs 190

Dveřní závěs 190

| kód | název | Typ povrchové úpravy | | | |
|-----------|-----------------------|----------------------|------|-------|-------|
| | | ŽL.POZ | POBR | BR.SP | POMOS |
| OCF190130 | Závěs 190/13 mm horní | 9 | 10 | 11 | 9 |
| OCG190130 | Závěs 190/13 mm dolní | 10 | 11 | 12 | 11 |
| OCI190130 | Závěs 190/13 mm sada | 19 | 21 | 23 | 20 |
| OCF190140 | Závěs 190/14 mm horní | 11 | 12 | × | 11 |
| OCG190140 | Závěs 190/14 mm dolní | 11 | 12 | × | 12 |
| OCI190140 | Závěs 190/14 mm sada | 22 | 24 | × | 23 |
| OCF190160 | Závěs 190/16 mm horní | 16 | 19 | 21 | 17 |
| OCG190160 | Závěs 190/16 mm dolní | 17 | 20 | 22 | 18 |
| OCI190160 | Závěs 190/16 mm sada | 33 | 39 | 43 | 35 |

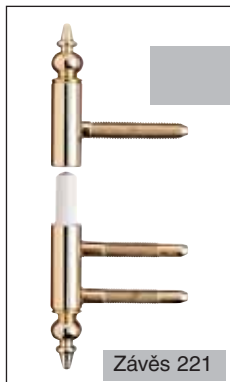

Závěs 221

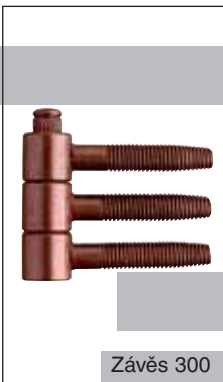

Závěs 300

Dveřní závěs 221

| | název | Typ povrchové úpravy | |
|-----------|-----------------------|----------------------|-------|
| | | BR.SP. | POMOS |
| OCF221150 | Závěs 221/15 mm horní | 35 | 49 |
| OCG221150 | Závěs 221/15 mm dolní | 52 | 60 |
| OCI221150 | Závěs 221/15 mm sada | 88 | 109 |

Dveřní závěs 300

| | název | Typ povrchové úpravy | |
|-----------|----------------------|----------------------|------|
| | | ŽL.POZ | POBR |
| OCI300140 | Závěs 300/14 mm sada | 28 | 30 |
| OCI300160 | Závěs 300/16 mm sada | 28 | 37 |



Závěs 320

Dveřní závěs 320

| kód | název | Typ povrchové úpravy | | |
|-----------|-----------------------------------|----------------------|------|-------|
| | | ŽL.POZ | POBR | POMOS |
| OCI320160 | Závěs 320/16 mm sada | 44 | 51 | 53 |
| OCI320180 | Závěs 320/18 mm sada | 61 | 64 | 68 |
| OCI320200 | Závěs 320/20 mm sada | 72 | 84 | 95 |
| OCI320200 | Závěs bezpečnostní 320/20 mm sada | 121 | × | × |

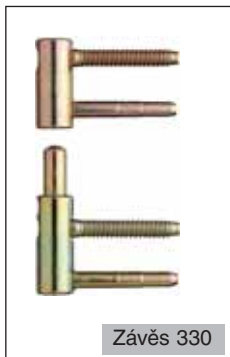

Závěs 330

Dveřní závěs 330

| kód | název | Typ povrchové úpravy | |
|-----------|----------------------|----------------------|-------|
| | | BR.SP. | POMOS |
| OCI330160 | Závěs 330/16 mm sada | 133 | 133 |



Závěs 495

Dveřní závěs 495

| kód | název | Typ povrchové úpravy | | |
|-----------|-----------------------|----------------------|--------|------|
| | | POZ | ŽL.POZ | POBR |
| OCF495140 | Závěs 495/14 mm horní | x | 45 | 29 |
| OCG495140 | Závěs 495/14 mm dolní | x | 66 | 42 |
| OCI495140 | Závěs 495/14 mm sada | x | 111 | 71 |
| OCF495160 | Závěs 495/16 mm horní | 51 | 51 | x |
| OCG495160 | Závěs 495/16 mm dolní | 75 | 75 | x |
| OCI495160 | Závěs 495/16 mm sada | 126 | 126 | x |
| OCF495200 | Závěs 495/20 mm horní | 95 | 98 | x |
| OCG495200 | Závěs 495/20 mm dolní | 105 | 110 | x |
| OCI495200 | Závěs 495/20 mm sada | 200 | 208 | x |

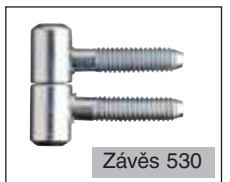

Závěs 530

Dveřní závěs 530

| kód | název | Typ povrchové úpravy | | | |
|-----------|-----------------------|----------------------|--------|------|-------|
| | | POZ | ŽL.POZ | POBR | POMOS |
| OCF530090 | Závěs 530/9 mm horní | x | 3 | 4 | 4 |
| OCG530090 | Závěs 530/9 mm dolní | x | 4 | 4 | 5 |
| OCI530090 | Závěs 530/9 mm sada | x | 7 | 8 | 9 |
| OCF530110 | Závěs 530/11 mm horní | 4 | 5 | x | 5 |
| OCG530110 | Závěs 530/11 mm dolní | 5 | 5 | x | 6 |
| OCI530110 | Závěs 530/11 mm sada | 9 | 10 | x | 11 |



Závěs 530

Dveřní závěs 605

| kód | název | Typ povrchové úpravy | | |
|-----------|-----------------------|----------------------|-------|-------|
| | | POBR | BR.SP | POMOS |
| OCF605090 | Závěs 605/9 mm horní | 6 | 7 | 6 |
| OCG605090 | Závěs 605/9 mm dolní | 6 | 7 | 6 |
| OCI605090 | Závěs 605/9 mm sada | 12 | 14 | 12 |
| OCF605110 | Závěs 605/11 mm horní | 8 | 9 | 9 |
| OCG605110 | Závěs 605/11 mm dolní | 9 | 10 | 10 |
| OCI605110 | Závěs 605/11 mm sada | 17 | 19 | 19 |

**Plastová destička**

| kód | název | černá |
|---------------|-------------------------|-------|
| OJR519070Y204 | Plastová destička černá | 28 |

Záklopka dveří

| kód | název | Typ povrchové úpravy | | | |
|-----------|-----------------------|----------------------|--------|------|-------|
| | | POZ | ŽL.POZ | POBR | POMOS |
| OLC260160 | Záklopka dveří 160 mm | 46 | 46 | 50 | 56 |
| OLC260200 | Záklopka dveří 200 mm | 49 | 49 | 54 | 66 |
| OLC260250 | Záklopka dveří 250 mm | x | 51 | 60 | 73 |
| OLC260300 | Záklopka dveří 300 mm | x | 54 | 63 | 79 |
| OLC260400 | Záklopka dveří 400 mm | x | 59 | 85 | 103 |
| OLC260500 | Záklopka dveří 500 mm | x | x | 100 | 114 |
| OLC260600 | Záklopka dveří 600 mm | x | x | 107 | 147 |
| OLC260800 | Záklopka dveří 800 mm | x | x | 161 | 229 |

**Okenní skoba**

| kód | název | Typ povrchové úpravy | |
|-----------|--------------------|----------------------|-------|
| | | POBR | POMOS |
| ONT245240 | Okenní skoba NT245 | 28 | 28 |



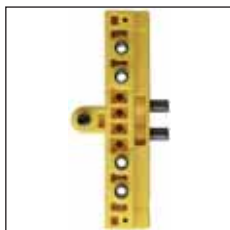
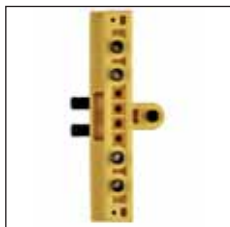

Šablona pro montáž dveřních závěsů

| kód | název | cena |
|--------------|--|------|
| OMC701130G06 | Šablona pro montáž dveřních závěsů ϕ 13 mm | 833 |
| OMC701140G06 | Šablona pro montáž dveřních závěsů ϕ 14 mm | 833 |
| OMC701160G06 | Šablona pro montáž dveřních závěsů ϕ 16 mm | 833 |
| OMC701160G03 | Šablona pro montáž dveřních závěsů ϕ 495/14/16 mm | 833 |
| OMC701180G03 | Šablona pro montáž dveřních závěsů ϕ 320/18 mm | 833 |
| OMC701200G00 | Šablona pro montáž dveřních závěsů ϕ 495/20 mm | 833 |
| OMC701200G03 | Šablona pro montáž dveřních závěsů ϕ 320/20 mm | 833 |